



InfraBuild

Building futures through sustainable steel

Know Your Steel

Steel Mass Reference and Product Catalogue

SEPTEMBER 2022 | Edition 7



Hot Rolled Structural | Tubular | Merchant Bar | Pipe & Fittings | Plate | Sheet
Reinforcing Mesh & Bar | Aluminium | Building Products | Fencing
Rural Products | Roofing & Rainwater | Accessories

[infrabuild.com](https://www.infrabuild.com)

Know Your Steel Mass Book

Foreword

This publication has been prepared by InfraBuild Steel Centre which is an operating business of InfraBuild Trading Pty Limited (ABN 50 007 519 646). The aim of this booklet is to provide customers with useful information regarding steel and accessory products. Every effort has been made to ensure that the information contained in this publication is accurate. However, it should be noted that the company cannot accept responsibility for errors or omissions, or for changes which have taken place since the printing of this edition. Unless required by law, the company cannot accept any responsibility for any loss, damage or consequence resulting from the use of this publication. The preferred range of sizes only has been covered, some of these sizes may be subject to minimum order quantities, and every care should be taken to establish availability before proceeding based on the specifications provided. Additional information concerning non-preferred sizes, range of specifications available, or related data not included in this booklet is available on request through InfraBuild Steel Centre Branches.

NOTE: Mass Calculations have been based on a mass for carbon steel of 7,850 kg/m³ rounded off and includes a 2.5 per cent rolling tolerance where applicable.

Trademarks

- Austube Mills Pty Ltd (ABN 21 123 666 679) - DuraGal, DuraGalClear, DuraPrimed, C450Plus
- OneSteel Manufacturing Pty Ltd - 300PLUS
- InfraBuild Trading Pty Limited (ABN 50 007 519 646) - DuraGal Flooring System
- InfraBuild Reinforcing Pty Limited (ABN 22 004 148 289) - HANDIMESH, ONEMESH, 500PLUS, UTEMESH
- BlueScope Steel Limited (ABN 16 000 011 058) - TruSpec, Xlerplate, Xlerplate Lite, Brightform, Blackform, Galvabond, Galvaskin, Zincanneal, Zinalume, Colorbond, LY-TEN, Lysaght, Longline 305, Multiclad, Easyclad, Quad 115 Hi Front, Trimline, Sheerline, Emline, Half Round, Ranceline, Colonial, Novaline, Bondek, W-Dek, Neetascreen, Smartascreen, Miniscreen, Customscreen, Flatdek, Flatdek II, Firmlok, Headland, Manor Red, Jasper, Sandbank, Classic Cream, Surfmist, Paperbark, Dune, Shale Grey, Windspray, Woodland Grey, Bushland, Pale Eucalypt, Wilderness, Cottage Green, Plantation, Blue Ridge, Deep Ocean, Night Sky
- Bisalloy Steels Pty Ltd (ABN 27 001 641 292) - Bisalloy® Wear, Bisalloy® Structural

- Stramit Corporation Pty Ltd (ABN 57 005 010 195) - Speed Deck Ultra, Corrugated, Mono clad, Mega clad, Longspan, Capacity Plus, Minirib, Mini Corry, PrimeForm, Edge Forma
- Illinois Tool Works Inc (ABN 48 052 404 092) - Galmet, Buildex, Tekes, Shed Tekes, Ripple Tekes, AutoTekes, SuperTEKS, RoofZips, Hi-Tekes, BattenZips, PolyZips, Pryda

Range

PLEASE NOTE:

- The product ranges shown in this book are an indicative range only.
- Some items may be subject to minimum order quantities.

Sources Of Information

- Liberty Steel - Product and Availability Guide - Hot Rolled Structural Steel
- InfraBuild Steel - Pricing and Availability Guide - Merchant Bar
- Austube Mills - Product and Availability Guide - Pipe and Tube Structural Products
- InfraBuild Reinforcing Product Guide
- BlueScope Steel Hot Rolled Price Schedule
- BlueScope Steel Xlerplate Price Schedule
- BlueScope Steel Xlerplate Lite Schedule
- BlueScope Steel - Aluminium Catalogue
- BlueScope Steel - Steel Guide

Terms & Conditions Of Sale

A full copy of InfraBuild Terms & Conditions of Sale is located at: www.infrabuild.com

Note: InfraBuild Steel Centre reserve the right to change specifications without notice. Not all products are available at all InfraBuild Steel Centre branches. InfraBuild Steel Centre also has access to a wide network of products not necessarily listed in this book. Please check with your local InfraBuild Steel Centre branch for product availability.

Note: InfraBuild Steel Centre reserve the right to change specifications without notice. Not all products are available at all InfraBuild Steel Centre branches. InfraBuild Steel Centre also has access to a wide network of products not necessarily listed in this book. Please check with your local InfraBuild Steel Centre branch for product availability.

Our Purpose

We exist to build our customers' possibilities: to make their businesses stronger and more prosperous; to make their trucks and caravans safer; to assist their farms to be more productive; to contribute to more sustainable and secure futures. From large projects to small, those that build our nation and our communities, we partner with customers to build the businesses we work in and the homes we live in. We help our customers to fulfil their ambitions with peace of mind that comes from quality, compliant and traceable product supply and service solutions.

We Understand

InfraBuild Steel Centre is Australia's largest vertically-integrated steel distribution business. With our extensive steel product knowledge and experience, our team helps our customers to find solutions to deliver the right outcomes for large or small projects, as well as ongoing steel supply requirements.

We Make It Easier

InfraBuild Steel Centre is backed by a national and international supply network to ensure our customers receive the best level of service to support their needs. Our wide-ranging in-house processing capability reduces complexity for our customers to reliably deliver on one-off and repeatable requirements with accuracy to add value.

We Deliver

InfraBuild Steel Centres' comprehensive branch and delivery network allows us to deliver to our customers how and when they want to receive product. Our integrated supply chain and network of industry partners means we can source a range of product to complement projects and deliver a complete supply solution.

Our Products

Our range includes structural and tubular steel, reinforcing and merchant bar, sheet and plate as well as pipes, valves and fittings, flooring systems, rollform products, aluminium and a huge range of complementary products and accessories. We also have the ability to source local and international products with short lead times.

Engineering & Design Optimisation

As part of the broader InfraBuild and Liberty Steel group of businesses, InfraBuild Steel Centre can draw on significant expertise to provide engineering and design optimisation solutions for our customers. Optimising materials for construction can assist with minimising risk while reducing waste and cost, and can also contribute to the sustainability credentials required for awarding Green Star® credit points.

Our Processing Services

- Profile Cutting
- Oxy Cutting
- Plasma Cutting
- Flame Cutting
- Stitch Cutting
- Punching
- Drilling
- Shearing
- Stamping
- Notching
- Marking
- Tapping
- Slotting
- Coping
- Beveling
- Penetrations
- Counter Boring
- Counter Sinking
- Cut to Length
- Pack Cutting
- Cambering

Compliance & Traceability

InfraBuild supplies products that are compliant with relevant Australian Standards. The quality of our products are checked by NATA endorsed testing laboratories. At all of our manufacturing sites, InfraBuild has third party accreditation to Quality Management System ISO 9001 and Environmental Management System ISO 14001. In addition, our hot rolled products are all produced at mills with ACRS third party accreditation ensuring certification for reinforcing, pre-stressing and structural steels. InfraBuild Steel Centre also supports the Build With Standards initiative undertaken by InfraBuild which aims to improve compliance and generate confidence in the quality, identification, certification and traceability of structural and reinforcing steels. Further information can be found at www.infrabuild.com



**Hot Rolled Structural | Tubular | Merchant Bar | Pipe & Fittings | Plate | Sheet
 Reinforcing Mesh & Bar | Aluminium | Building Products | Fencing
 Rural Products | Roofing & Rainwater | Accessories**

Note: InfraBuild Steel Centre reserve the right to change specifications without notice. Not all products are available at all InfraBuild Steel Centre branches. InfraBuild Steel Centre also has access to a wide network of products not necessarily listed in this book. Please check with your local InfraBuild Steel Centre branch for product availability.

The Infrastructure Sustainability Council's (ISC) IS Rating Scheme.



ISC aims to improve the productivity and liveability of industry and communities through sustainability in infrastructure. ISC developed and administers the Infrastructure Sustainability (IS) Rating Scheme.

The IS scheme is Australia's only comprehensive rating system for evaluating sustainability across design, construction and operation of infrastructure.

The scheme evaluates the sustainability (including environmental, social, economic and governance aspects) of infrastructure projects and assets.

There are two versions of the IS materials calculator. Projects will be awarded an IS Rating based on an overall score:

ISv1.2

There are up to 7 points available under the materials category; 6 points for the materials calculator and 1 point for environmentally labelled products.

ISv1.2	
Points	Rating Level
25 – 49+	Commended
50 – 74+	Excellent
75+	Leading

Related ISv1.2 Credits
Mat-1, Mat-2, Pro-2, Pro-4, Was-1, Was-2, Was-3
Rating Phases: As Built, Design, Planning

ISv2.0

There are up to 6 points available under the materials category; 4.5 points for the materials calculator and 1.5 points for environmentally labelled products.

ISv2.0	
Points	Rating Level
25 – 39	Bronze
40 – 59	Silver
60 – 79	Gold
80 – 94	Platinum
95+	Diamond

Related ISv2.0 Credits
Ecn-1, Ecn-4, Inn-1, Lea-1, Lea-2, Lea-3, Rso-4, Rso-5, Rso-6, Rso-7, Spr-2, Spr-3, Wfs-4
As Built, Design, Operations

Under Both Versions

Up to three points are available to reward design and practice that reduces life cycle impacts via reduced material use such as Prefabricated Reinforcing Elements, Engineered Reinforcing Bar Carpet (BAMTEC®) or Engineered Mat (BARMAT®).

Up to three points are available to reward environmentally labelled products and supply chains:

- **One point is available** via the use of products covered by our EPDs
- **Two additional points are available** if >9% of materials/products (by value) have an ISC- approved environmental label, such as InfraBuild's EPD.

Sustainability Outcomes

InfraBuild publishes Environmental Product Declarations (EPDs) that cover our hot-rolled steel, reinforcing bar and reinforcing mesh products. InfraBuild EPDs may help your project achieve credits with ISv2.0 and ISv1.2.

InfraBuild also publishes Corporate Sustainability reports.

InfraBuild has a range of policies and procedures that demonstrates strong social, economic, safety and environmental credentials, which may contribute to additional IS credits such as ISv2.0 Lea-1, Lea-2, Lea-3, Inn-1 Spr-2, Spr-3, Rso-4, Rso-6, Wfs-4 (L3.4), Ecn-1 and Ecn-4 and ISv1.2 Mat-1, Mat-2, Pro-2, Pro-4, Was-1, Was-2, Was-3.

Early collaboration with InfraBuild fosters opportunities for innovation, reduced environmental impacts, risk minimisation, knowledge sharing, offsite fabrication, design and logistics optimisation and waste minimisation, as well as broader supply chain engagement contributing to the above credits.

InfraBuild's products are all manufactured to the relevant Australian Standards. InfraBuild has ACRS Certification for our reinforcing products, which further underpins our strong compliance credentials.

Our product traceability and transparency through the supply chain provides confidence to the market that the material supplied meets the design, quality and sustainability specifications of the project.

Read more about the IS Rating Scheme at the ISC website (<https://www.iscouncil.org/>).

Steel Credit Points

The Green Building Council of Australia (GBCA) is a national authority on sustainable buildings, communities and cities.



- The GBCA administers the Green Star® environmental rating system for commercial, residential, industrial, healthcare and education buildings. In Australia, Green Star® is a trusted mark of quality for the design, construction and operation of sustainable buildings, fit-outs and communities
- Green Star® ratings are utilised by the majority of CBD commercial multi-storey developments and government projects
- In 2017, the Green Building Council of Australia updated its Design and As Built Guidelines.
- The following lists the Steel Credit points that may be available through using InfraBuild’s products under the current guidelines v1.3:

Points under D&AB Tool		
Points	Rating	Outcome
45 – 59	Four Star	Australian Best Practice
60 – 74	Five Star	Australian Excellence
75+	Six Star	World Leadership

Life Cycle Impacts – Steel Credit 19B.2B – Points available: 1

- **One point is available** where project teams can demonstrate a reduction in the mass of steel framing used in the building when compared to standard practice.

There are available pathways to achieving this Credit:

- A.19B.2A.A** – through the use of a minimum proportion of high strength steel
- B.19B.2A.B** – by demonstrating that the project results in a 5% or more reduction in mass of steel framing, when compared to a suitable reference case building.

Responsible Building Materials Credit 20.1A – Points available: 1

- **One point is available** where 95% of the building’s steel (by mass) is sourced from a responsible steel maker and at least 60% (by mass) of the fabricated structural steelwork is supplied by a steel fabricator / steel contractor accredited to the Environmental Sustainability Charter of the Australian Steel Institute.
- InfraBuild meets the two requirements of being a “Responsible Steel Maker” by having
 - i) A currently valid and certified ISO 14001 Environmental Management System (EMS) in place
 - ii) Membership of the worldsteel Climate Action Program Certification to demonstrate the above is available from the InfraBuild website.

Sustainable Products – Credit 21

- **Up to three (3) points** are available when project teams can demonstrate that a specified percentage of eligible products meet one of the following initiatives:
 - A.** Reused Products, in accordance with 21A
 - B.** Recycled Content Products, in accordance with 21B
 - C.** Environmental Product Declarations, in accordance with 21C
 - D.** Third-Party Certification, in accordance with 21D, or
 - E.** Stewardship Programs, in accordance with 21E.

Points are awarded based on the percentage value of the products that meet one of the specified initiatives. This is demonstrated by calculating the Project Sustainability Value (PSV) and comparing it with the Project Contract Value (PCV) as a percentage.

InfraBuild can help achieve the Green Star® steel credit requirements in the following ways:

- InfraBuild Steel Centre sources a range of products from mills with a valid ISO 14001 Environmental Management System
- InfraBuild Steel Centre sources a range of products from mills with membership of the worldsteel Climate Action Programme
- InfraBuild Steel Centre can assist in Credit 21 of the GBCA Green Star scheme

For more information on Green Star® related products visit the Green Star page of our website.



National Branch Network

InfraBuild Steel Centres' extensive national branch network provides solutions for our customers, wherever they need them.



Safety at Our Sites

At InfraBuild we have set ourselves a safety goal of < 2 TRIFR (Total Recordable Injury Frequency Rate) by 2025. We have a roadmap to get us there called – WRIB Safe. All of our safety actions and behaviours are underpinned by our 'Be GFG Safe' global strategy to ensure every employee returns home fit and well at the end of each workday. By working together as one team, with respect for one another, we build our safety culture. We take the time to do things safely, to intervene, and to speak up when we notice a risk or hazard. At InfraBuild, we believe one injury is one too many.



We appreciate your compliance with our safety policies when you visit our sites.

Hot rolled structural | tubular | merchant bar | pipe & fittings | plate | sheet reinforcing mesh & bar | aluminium | building products | fencing rural products | roofing & rainwater | accessories

www.infrabuild.com

Our Valued Supply Partners

InfraBuild Steel Centre stock and supply quality products from suppliers and brands our customers know and trust.



Note: InfraBuild Steel Centre reserve the right to change specifications without notice. Not all products are available at all InfraBuild Steel Centre branches. InfraBuild Steel Centre also has access to a wide network of products not necessarily listed in this book. Please check with your local InfraBuild Steel Centre Branch for product availability.

Structural

Equal Angles	10
Unequal Angles	10
Universal Beams	11
Welded Beams	11
Taper Flange Beams	12
Universal Columns	13
Welded Columns	13
Parallel Flange Channels	14
Rails	14

Bar Sections

Equal Angles	16
Unequal Angles	17
Flat Bars – Round Edge	17
Flat Bars – Square Edge	18
Round Bars	21
Square Bars	22
Parallel Flange Channels	22
Billets	23
DuraGal® Channels	23
DuraGal® Angles	24
DuraGal® Flat Bars	26

Tubular

Square Hollow Sections (SHS)	27
Rectangular Hollow Sections (RHS)	29
Stock Rail and Posts	32
Silo Sections	32
Stock Rail Accessories	33
Circular Hollow Sections (CHS)	33
Structural CHS	39
Telescoping RHS	41
Telescoping SHS	42
Telescoping CHS	44
End Colour Codes	46

Plate

Flat Plate G250	47
Flat Plate G350	49
K1042 Plate	50
Pressure Vessel Plate	50
Floor Plate G250	51
Coil Plate HA250	51
Floor Plate HA250	52
Coil Plate HA350	52
Wear Plate	53
Structural Plate	54

Sheet and Coil

BRIGHTFORM® Sheet	55
Hot Rolled Sheet	56
Hot Rolled, Pickled and Oiled Sheet	56
Cold Rolled Sheet	57
GALVABOND® Sheet	58
ZINCANNEAL® Sheet	59
ZINCALUME® Sheet	60
COLORBOND® Sheet	61

Reinforcing Bar and Mesh

HANDIMESH®	62
UTE MESH®	62
ONEMESH®	62
Plain Square Mesh	63
Trench Mesh	63
Deformed Reinforcing Bar	64
Reinforcing Accessories	65

Aluminium

Aluminium Circular Tube	66
Aluminium Rectangular Tube	67
Aluminium Square Tube	68
Aluminium Angles	69
Aluminium Channels	70
Aluminium Tees	71
Aluminium Round Bars	71
Aluminium Flat Bars	72
Aluminium Square Bars	72
Aluminium Sheet and Plate	73

Stainless Steel

Stainless Steel Angles	75
Stainless Steel Sheet and Coil	75
Stainless Steel Flat Bars	76
Stainless Steel Round Bars	77

Walkway Systems

Grating and Flooring	78
Stair Stringers	79
Stair Treads	80
Non-Weld Handrail Systems	81

Building Products

DuraGal Flooring System®	85
DuraGal® Mezzanine Flooring System	85
Lintels – Traditional	86
Lintels – Flat and Angle	87
C-Purlins	90
Z-Purlins	90
Battens, Roofing and Walling	92
Flashings	94
COLORBOND® Steel Colour Range	94
Rainwater Products	95
Structural Products	97
Gutters and Fascia	97
Structural Decking	97
Fencing	98

Piping Systems

Steel Pipes to American Standards	99
Stainless Steel Pipes to American Standards	101
Carbon Steel Buttweld Fittings	101
Flanges to American Standards	102
Bolting for ANSI Flanges	103
Buttweld Fittings and Flanges to ASME Standards	104
Flanges to Australian Standards	105
ISO Metric Hexagon Steel Bolts	106

Fencing and Fittings

Fabricated Fencing	107
Fence Wire	108
Trellis Wire	108
Tie Wire	109
Barbed Wire	109
Netting	109
Posts	111
Gates	112
Fittings, Clamps, Hinges and Gudgeons	113

Fasteners

Fasteners	115
-----------	-----

General Information

Geometry and Mensuration	116
Gauge Conversions	116
Conversion Tables	117
Useful Conversion Factors	118
Handy Tips	120
Relevant Australian Standards	121

300PLUS® structural steel | C450PLUS™ structural tube



In April 2016, revisions to four Australian Standards and two Technical Specifications covering structural steels were released by Standards Australia.



These releases address increasing concerns in the construction industry about the non-compliance of building materials and the risk they pose to the industry and the community generally. Specifying and procuring compliant product reduces your professional risk and the safety risk to the community. Projects that specify these new Standards and Technical Specifications will be in a better position to manage the risk that would otherwise exist.

The following mandatory requirements in the Australian Standards provide you with confidence you are getting quality and compliant steel products:

Minimum specific information on Test Certificates:

- Testing to be performed by laboratories with third party accreditation from NATA
- Individual length identification markings

The four Standards are:

- AS/NZS 1163-2016 – Cold-formed structural steel hollow sections
- AS/NZS 3678-2016 Structural steel – Hot rolled plates, floorplates and slabs
- AS/NZS 3679.1-2016 – Structural steel – Part 1: Hot-rolled bars and sections
- AS/NZS 3679.2-2016 – Structural steel – Part 2: Welded I sections

The two Technical Specifications:

- SA TS 102-2016 – Structural steel – Limits on elements added
- SA TS 103-2016 – Welding to AS/NZS 1554 Parts 1, 5 and 7– Limits on boron in parent materials

Structural

Equal Angles

Various Standard Lengths

Size mm x mm x mm	Mass kg/m	Metres per tonne
125 x 125 x 8	14.9	67
125 x 125 x 10	18.0	56
125 x 125 x 12	22.5	44
125 x 125 x 16	29.1	34
150 x 150 x 10	21.9	46
150 x 150 x 12	27.3	37
150 x 150 x 16	35.4	28
150 x 150 x 19	42.1	24
200 x 200 x 13	40.0	25
200 x 200 x 16	48.7	21
200 x 200 x 18	54.4	18
200 x 200 x 20	60.1	17
200 x 200 x 26	76.8	13

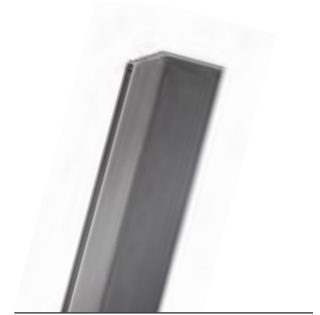

Note: See page 14 for Merchant Bar Equal Angles.

Typical Uses:

- Engineering Construction
- Residential Construction
- Non-Residential Construction
- Mining Infrastructure
- Transport and Storage
- Manufacturing

Features:

- Meets AS/NZS 3679.1:2016
- Up to 20% stronger for improved strength to weight ratios
- Requires no special pre-heating for welding

Unequal Angles

Various Standard Lengths

Size mm x mm x mm	Mass kg/m	Metres per tonne
150 x 90 x 8	14.3	70
150 x 90 x 10	17.3	58
150 x 90 x 12	21.6	46
150 x 90 x 16	27.9	36
150 x 100 x 10	18.0	56
150 x 100 x 12	22.5	44



Note: See page 15 for Merchant Bar Unequal Angles.

Typical Uses:

- Engineering Construction
- Residential Construction
- Non-Residential Construction
- Mining Infrastructure
- Transport and Storage
- Manufacturing

Features:

- Meets AS/NZS 3679.1:2016
- Up to 20% stronger for improved strength to weight ratios
- Requires no special pre-heating for welding

Universal Beams

Various Standard Lengths

Metric Designation	Size mm x mm	Mass kg/m	Metres per tonne
150 UB	150 x 75	14.0	71
150 UB	155 x 75	18.0	56
180 UB	173 x 90	16.1	62
180 UB	175 x 90	18.1	55
180 UB	179 x 90	22.2	45
200 UB	198 x 99	18.2	55
200 UB	202 x 133	22.3	45
200 UB	203 x 133	25.4	39
200 UB	207 x 134	29.8	34
250 UB	248 x 124	25.7	39
250 UB	252 x 146	31.4	32
250 UB	256 x 146	37.3	27
310 UB	298 x 149	32.0	31
310 UB	304 x 165	40.4	25
310 UB	307 x 166	46.2	22
360 UB	352 x 171	44.7	22
360 UB	356 x 171	50.7	20
360 UB	359 x 172	56.7	18
410 UB	403 x 178	53.7	19
410 UB	406 x 178	59.7	17
460 UB	454 x 190	67.1	15
460 UB	457 x 190	74.6	13
460 UB	460 x 191	82.1	12
530 UB	528 x 209	82.0	12
530 UB	533 x 209	92.4	11
610 UB	602 x 228	101	10
610 UB	607 x 228	113	9
610 UB	612 x 229	125	8



Typical Uses:

- Engineering Construction
- Residential Construction
- Non-Residential Construction
- Mining Infrastructure
- Transport and Storage
- Manufacturing

Features:

- Meets AS/NZS 3679.1:2016
- Up to 20% stronger for better strength to weight ratios
- Requires no special pre-heating for welding



Structural Processing

InfraBuild Steel Centre can offer processing for Structural Steel sections using a variety of machinery including Beamlines, Band Saws and Cambering Machines.

Applications include: Straight cuts, pack cuts, mitre cutting, drilling and cambering.

Call your local branch to discuss your requirements

Welded Beams

Various Standard Lengths

Metric Designation	Mass kg/m	Size mm x mm	Metres per tonne
700 WB	115	692 x 250	8.70
700 WB	130	700 x 250	7.69
700 WB	150	710 x 250	6.67
700 WB	173	716 x 275	5.78
800 WB	122	792 x 250	8.20
800 WB	146	800 x 275	6.85
800 WB	168	810 x 275	5.95
800 WB	192	816 x 300	5.21
900 WB	175	900 x 300	5.71
900 WB	218	910 x 350	4.59
900 WB	257	916 x 400	3.89
900 WB	282	924 x 400	3.55
1000 WB	215	1000 x 300	4.65
1000 WB	258	1010 x 350	3.88
1000 WB	296	1016 x 400	3.38
1000 WB	322	1024 x 400	3.11
1200 WB	249	1170 x 275	4.02
1200 WB	278	1170 x 350	3.60
1200 WB	317	1176 x 400	3.15
1200 WB	342	1184 x 400	2.92
1200 WB	392	1184 x 500	2.55
1200 WB	423	1192 x 500	2.36
1200 WB	455	1200 x 500	2.20

Note: Made to order. Lead times may apply.

Taper Flange Beams

Various Standard Lengths

Size mm x mm x mm	Mass kg/m	Metres per tonne
100 x 45	7.20	139
125 x 65	13.1	76

Typical Uses:

- Engineering Construction
- Residential Construction
- Non-Residential Construction
- Mining Infrastructure
- Transport and Storage Manufacturing

Features:

- Meets AS/NZS 3679.1:2016



Typical Uses:

- Engineering Construction
- Residential Construction
- Non-Residential Construction
- Mining Infrastructure
- Transport and Storage
- Manufacturing

Features:

- Meets AS/NZS 3679.2:2016
- Up to 20% stronger for improved strength to weight ratios
- Requires no special pre-heating for welding



Universal Columns

Various Standard Lengths

Metric Designation	Mass kg/m	Size mm x mm	Metres per tonne
100 UC	14.8	97 x 99	68
150 UC	23.4	152 x 152	43
150 UC	30.0	158 x 153	33
150 UC	37.2	162 x 154	27
200 UC	46.2	203 x 203	22
200 UC	52.2	206 x 204	19
200 UC	59.5	210 x 205	17
250 UC	72.9	254 x 254	14
250 UC	89.5	260 x 256	11
310 UC	96.8	308 x 305	10
310 UC	118	315 x 307	8
310 UC	137	321 x 309	7
310 UC	158	327 x 311	6



Typical Uses:

- Engineering Construction
- Residential Construction
- Non-Residential Construction
- Mining Infrastructure
- Transport and Storage
- Manufacturing

Features:

- Meets AS/NZS 3679.1:2016
- Up to 20% stronger for better strength to weight ratios
- Requires no special pre-heating for welding

Welded Columns

Various Standard Lengths

Metric Designation	Mass kg/m	Size mm x mm	Metres per tonne
350WC	197	331 x 350	5.08
350WC	230	339 x 350	4.35
350WC	258	347 x 350	3.88
350WC	280	355 x 350	3.57
400WC	144	382 x 400	6.94
400WC	181	390 x 400	5.52
400WC	212	400 x 400	4.72
400WC	270	414 x 400	3.70
400WC	303	422 x 400	3.30
400WC	328	430 x 400	3.05
400WC	361	430 x 400	2.77
500 WC	228	490 x 500	4.39
500 WC	267	500 x 500	3.75
500 WC	290	506 x 500	3.45
500 WC	340	514 x 500	2.94
500 WC	383	472 x 500	2.61
500 WC	414	480 x 500	2.42
500 WC	440	480 x 500	2.27



Features:

- Meets AS/NZS 3679.2:2016

Note: Made to order. Lead times may apply.

Parallel Flange Channels

Various Standard Lengths

Size mm × mm × mm	Mass kg/m	Metres per tonne
150 × 75	17.7	56.5
180 × 75	20.9	47.8
200 × 75	22.9	43.7
230 × 75	25.1	39.8
250 × 90	35.5	28.2
300 × 90	40.1	24.9
380 × 100	55.2	18.1

Typical Uses:

- Engineering Construction
- Residential & Non-Residential Construction
- Mining Infrastructure
- Transport and Storage
- Manufacturing

Features:

- Meets AS/NZS 3679.1:2016
- Up to 20% stronger for improved strength to weight ratios.
- Requires no special pre-heating for welding.



Note: See page 20 for Small Channel Sections.

Rails

Section	Mass kg/m	Metres per tonne
10	10.1	99.0
15	15.2	65.8
22	22.3	44.8
30	30.1	33.2
41	40.8	24.5
50	50.6	19.8
53	53.0	18.9
60	60.6	16.5
68	67.5	14.8
73	73.6	13.9
86	85.5	11.7

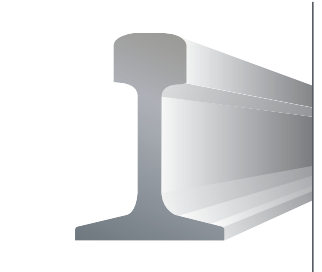

Note: Rails are not normally a stocked item, lead times may apply.

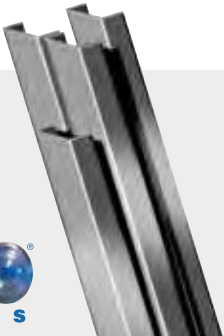



Rely on the strength of 300PLUS®

- Manufactured in Australia by Liberty Steel
- Available across the entire Merchant Bar and Structural Steel Ranges
- Up to 20% extra strength – improved strength to weight ratios mean your constructions can save weight, as well as money
- Can be readily welded without requiring special pre-heating

Call your local branch to discuss your requirements

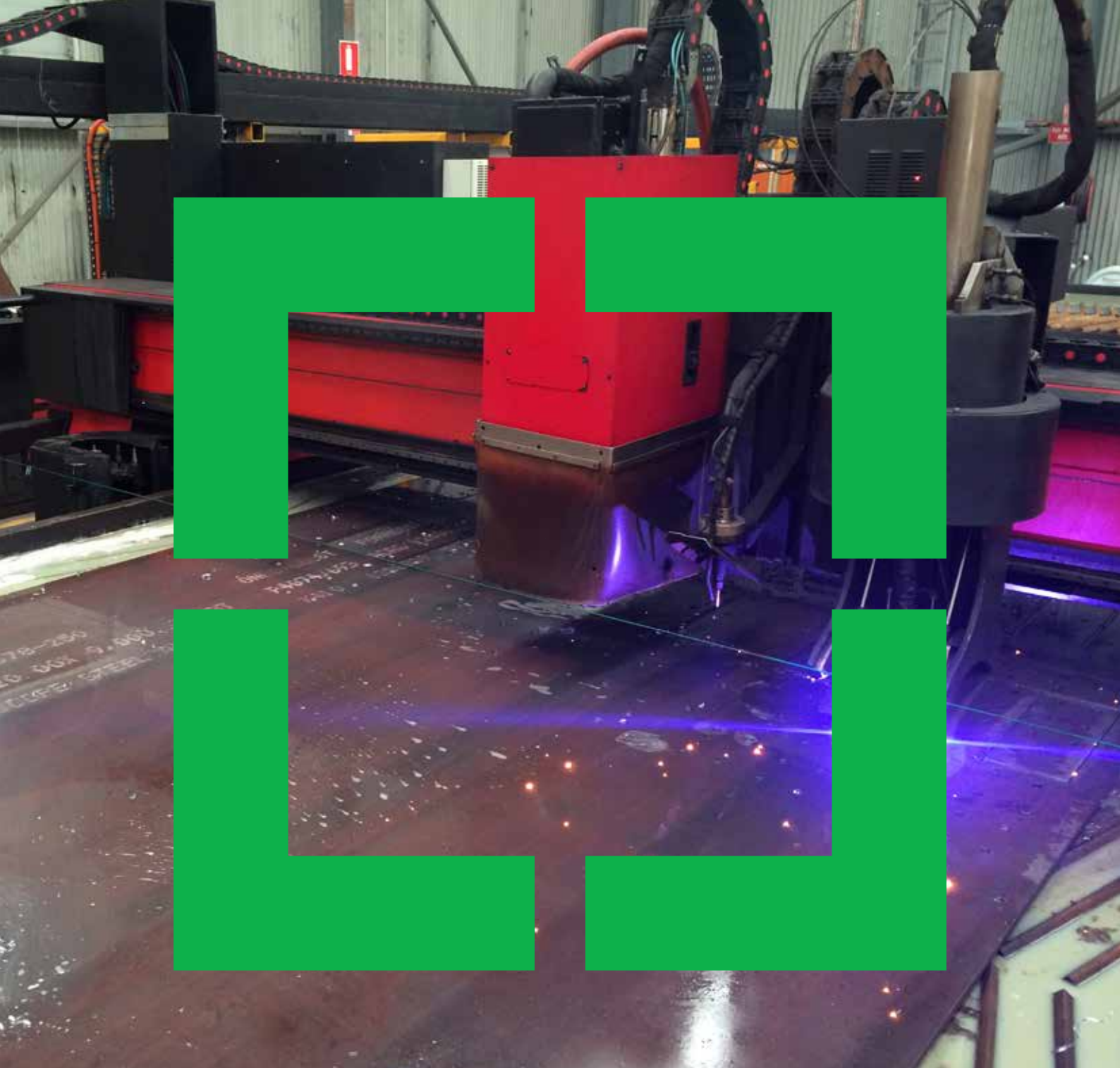
Note: InfraBuild Steel Centre reserve the right to change specifications without notice. Not all products are available at all InfraBuild Steel Centre branches. InfraBuild Steel Centre also has access to a wide network of products not necessarily listed in this book. Please check with your local InfraBuild Steel Centre branch for product availability.



Processing Solutions

At InfraBuild Steel Centre we make it easier with steel supplied and processed in one place. With processing equipment owned and operated by InfraBuild Steel Centre, you can consult our experts at every stage of your project to manage your processing requirements. Whether it's accuracy, tolerance or repeatability you need, we can help you achieve this through our fully-programmable machinery and the extensive experience of our people. Our industry knowledge and national support network ensures you and your projects receive the highest level of service and support.

Bar Sections

Equal Angles

Various Standard Lengths

Size mm x mm x mm	Mass kg/m	Metres per tonne
25 x 25 x 3	1.12	893
25 x 25 x 5	1.65	606
25 x 25 x 6	2.08	481
30 x 30 x 3	1.35	741
30 x 30 x 5	2.01	498
30 x 30 x 6	2.56	391
40 x 40 x 3	1.83	546
40 x 40 x 5	2.73	366
40 x 40 x 6	3.50	286
50 x 50 x 3	2.31	433
50 x 50 x 5	3.48	287
50 x 50 x 6	4.46	224
50 x 50 x 8	5.68	176
55 x 55 x 5	3.84	260
55 x 55 x 6	4.93	203
65 x 65 x 5	4.56	219
65 x 65 x 6	5.87	170
65 x 65 x 8	7.51	133
65 x 65 x 10	9.02	111
75 x 75 x 5	5.27	190
75 x 75 x 6	6.81	147
75 x 75 x 8	8.73	115
75 x 75 x 10	10.5	95
90 x 90 x 6	8.22	122
90 x 90 x 8	10.6	94
90 x 90 x 10	12.7	79
100 x 100 x 6	9.16	109
100 x 100 x 8	11.8	85
100 x 100 x 10	14.2	70
100 x 100 x 12	17.7	56



Note: See page 8 for Structural Angles.

Typical Uses:

- Engineering Construction
- Residential Construction
- Non-Residential Construction
- Mining Infrastructure
- Transport and Storage
- Manufacturing

Features:

- Meets AS/NZS 3679.1:2016
- Up to 20% stronger for improved strength to weight ratios
- Requires no special pre-heating for welding

Unequal Angles

Various Standard Lengths

Size mm x mm x mm	Mass kg/m	Metres per tonne
65 x 50 x 5	4.02	249
65 x 50 x 6	5.16	194
65 x 50 x 8	6.59	152
75 x 50 x 5	4.40	227
75 x 50 x 6	5.66	177
75 x 50 x 8	7.23	138
100 x 75 x 6	7.98	125
100 x 75 x 8	10.3	97
100 x 75 x 10	12.4	81
125 x 75 x 6	9.16	109
125 x 75 x 8	11.8	85
125 x 75 x 10	14.2	70
125 x 75 x 12	17.7	57



Note: See page 8 for Structural Angles.

Typical Uses:

- Engineering Construction
- Residential Construction
- Non-Residential Construction
- Mining Infrastructure
- Transport and Storage
- Manufacturing

Features:

- Meets AS/NZS 3679.1:2016
- Up to 20% stronger for improved strength to weight ratios
- Requires no special pre-heating for welding

Flat Bars - Round Edge

Standard Length 4.0m

Size mm x mm x mm	Mass kg/m	Metres per tonne
10 x 3	0.25	4000
13 x 3	0.32	3125
13 x 5	0.53	1887
13 x 6	0.65	1538
16 x 3	0.40	2500
16 x 5	0.66	1515
16 x 8	1.06	943

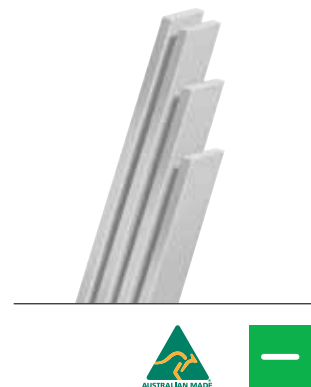

Note: Mass Calculations include a 2.5 per cent rolling tolerance for this product.

Typical Uses:

- Engineering Construction
- Residential Construction
- Non-Residential Construction
- Mining Infrastructure
- Transport and Storage
- Manufacturing

Features:

- Meets AS/NZS 3679.1:2016
- Requires no special pre-heating for welding

Flat Bars - Square Edge

Standard Length 6.0m

Size mm x mm x mm	Mass kg/m	Metres per tonne
20 x 3	0.48	2083
20 x 5	0.81	1235
20 x 6	0.96	1042
20 x 10	1.61	621
25 x 3	0.60	1667
25 x 5	1.00	1000
25 x 6	1.21	826
25 x 8	1.61	621
25 x 10	2.01	498
25 x 12	2.42	413
32 x 3	0.77	1299
32 x 5	1.29	775
32 x 6	1.55	645
32 x 8	2.06	485
32 x 10	2.57	389
32 x 12	3.09	324
40 x 3	0.96	1042
40 x 5	1.61	621
40 x 6	1.93	518
40 x 8	2.57	389
40 x 10	3.22	311
40 x 12	3.86	259
40 x 16	5.15	194
40 x 20	6.44	155
50 x 3	1.21	826
50 x 5	2.01	498
50 x 6	2.42	413
50 x 8	3.22	311
50 x 10	4.03	248
50 x 12	4.83	207
50 x 16	6.44	155
50 x 20	8.05	124
50 x 25	10.1	99
65 x 3	1.57	637
65 x 5	2.61	383
65 x 6	3.14	318
65 x 8	4.18	239
65 x 10	5.23	191
65 x 12	6.27	159
65 x 16	8.36	120
65 x 20	10.5	95
65 x 25	13.1	76
75 x 5	3.01	332
75 x 6	3.62	276
75 x 8	4.83	207
75 x 10	6.04	166



Typical Uses:

- Engineering Construction
- Residential Construction
- Non-Residential Construction
- Mining Infrastructure
- Transport and Storage
- Manufacturing

Features:

- Meets AS/NZS 3679.1:2016
- Up to 20% stronger for improved strength to weight ratios
- Requires no special pre-heating for welding

Note: Mass Calculations include a 2.5 per cent rolling tolerance for this product.

Flat Bars - Square Edge

Standard Length 6.0m

Size mm x mm x mm	Mass kg/m	Metres per tonne
75 x 12	7.25	138
75 x 16	9.66	104
75 x 20	12.1	83
75 x 25	15.1	66
90 x 5	3.62	276
90 x 6	4.35	230
90 x 8	5.79	173
90 x 10	7.25	138
90 x 12	8.69	115
100 x 5	4.03	248
100 x 6	4.83	207
100 x 8	6.44	155
100 x 10	8.05	124
100 x 12	9.66	104
100 x 16	12.9	78
100 x 20	16.1	62
100 x 25	20.1	50
100 x 50	40.3	25
110 x 6	5.31	188
110 x 8	7.08	141
110 x 10	8.86	113
110 x 12	10.7	93
130 x 5	5.23	191
130 x 6	6.27	159
130 x 8	8.36	120
130 x 10	10.5	95
130 x 12	12.5	80
130 x 16	16.7	60
130 x 20	20.9	48
130 x 25	26.1	38
150 x 5	6.04	166
150 x 6	7.25	138
150 x 8	9.66	104
150 x 10	12.1	83
150 x 12	14.5	69
150 x 16	19.3	52
150 x 20	24.2	41
150 x 25	30.1	33
150 x 50	60.4	17
180 x 5	7.25	138
180 x 6	8.69	115
180 x 10	14.5	69
180 x 12	17.4	57
180 x 16	23.2	43
180 x 20	29.0	34
180 x 25	36.2	28



Typical Uses:

- Engineering Construction
- Residential Construction
- Non-Residential Construction
- Mining Infrastructure
- Transport and Storage
- Manufacturing

Features:

- Meets AS/NZS 3679.1:2016
- Up to 20% stronger for improved strength to weight ratios
- Requires no special pre-heating for welding

Note: Mass Calculations include a 2.5 per cent rolling tolerance for this product.

Flat Bars - Square Edge

Standard Length 6.0m

Size mm x mm x mm	Mass kg/m	Metres per tonne
200 x 6	9.66	104
200 x 8	12.9	78
200 x 10	16.1	62
200 x 12	19.3	52
200 x 16	25.7	39
200 x 20	32.2	31
200 x 25	40.3	25
250 x 6	12.1	83
250 x 8	16.1	62
250 x 10	20.1	50
250 x 12	24.2	41
250 x 16	32.2	31
250 x 20	40.3	25
250 x 25	50.3	20
300 x 6	14.5	69
300 x 8	19.3	52
300 x 10	24.2	41
300 x 12	29.0	34
300 x 16	38.6	26
300 x 20	48.3	21
300 x 25	60.4	17

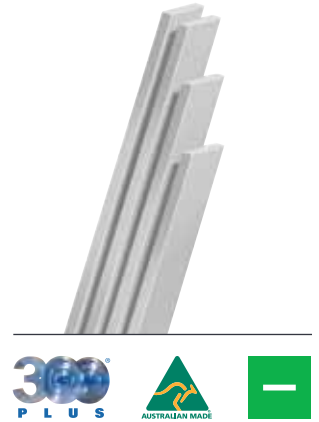

Note: Mass Calculations include a 2.5 per cent rolling tolerance for this product.

Typical Uses:

- Engineering Construction
- Residential Construction
- Non-Residential Construction
- Mining Infrastructure
- Transport and Storage
- Manufacturing

Features:

- Meets AS/NZS 3679.1:2016
- Up to 20% stronger for improved strength to weight ratios
- Requires no special pre-heating for welding

Round Bars

Standard Length 6.0m

Size mm x mm x mm	Mass kg/m	Metres per tonne
10	0.64	1563
12	0.91	1099
14	1.24	806
16	1.62	617
18	2.05	488
20	2.53	395
22	3.05	328
24	3.64	275
27	4.61	217
30	5.69	176
33	6.88	145
36	8.19	122
39	9.61	104
42	11.2	89
45	12.8	78
48	14.6	68
50	15.8	63
56	19.8	51
60	22.8	44
65	26.7	37
75	35.6	28
80	40.5	25
90	51.1	20
100	63.2	16
110	76.7	13
120	91.2	11
130	108	9
140	124	8
150	142	7
160	162	6
170	183	5
180	206	5
190	229	4
200	253	4



Note: Mass Calculations include a 2.5 per cent rolling tolerance for this product.

Typical Uses:

- Engineering Construction
- Residential Construction
- Non-Residential Construction
- Mining Infrastructure
- Transport and Storage
- Manufacturing

Features:

- Meets AS/NZS 3679.1:2016
- Up to 20% stronger for improved strength to weight ratios
- Requires no special pre-heating for welding

Square Bars

Standard Length 6.0m

Size mm × mm × mm	Mass kg/m	Metres per tonne
10 x 10	0.81	1235
12 x 12	1.16	862
16 x 16	2.06	485
20 x 20	3.22	311
25 x 25	5.03	199
32 x 32	8.24	121
40 x 40	12.9	78

Typical Uses:

- Engineering Construction
- Residential & Non-Residential Construction
- Mining Infrastructure
- Transport and Storage
- Manufacturing

Features:

- Meets AS/NZS 3679.1:2016
- Up to 20% stronger for improved strength to weight ratios
- Requires no special pre-heating for welding



Note: Mass Calculations include a 2.5 per cent rolling tolerance for this product.

Parallel Flange Channels

Various Standard Lengths

Size mm × mm × mm	Mass kg/m	Metres per tonne
75 x 40	5.92	169
100 x 50	8.33	120
125 x 65	11.9	84

Typical Uses:

- Engineering Construction
- Residential & Non-Residential Construction
- Mining Infrastructure
- Transport and Storage
- Manufacturing

Features:

- Meets AS/NZS 3679.1:2016
- Up to 20% stronger for improved strength to weight ratios
- Requires no special pre-heating for welding



Note: See page 12 for Structural Steel Channels.

Billets

Standard Length 6.0m

Size mm x mm x mm	Mass kg/m	Metres per tonne
45 x 45	16.3	61
50 x 50	19.4	52
63 x 63	31.2	32
75 x 75	45.3	22



DuraGal[®] Channels

Dim 1	Dim 2	Nominal Thickness mm	Length	Mass kg/m	Metres per tonne	Length/Pack			
						Standard (m)			
75	x	40	x	4	9000	4.43	226	18	
100	x	50	x	4	9000	5.58	179	18	
125	x	65	x	4	9000	7.60	132	18	
150	x	75	x	5	12000	11.2	89		12
180	x	75	x	5	12000	12.4	81		12
200	x	75	x	5	12000	13.2	76		12
200	x	75	x	6	12000	15.7	64		12
230	x	75	x	6	12000	17.2	58		12
250	x	90	x	6	12000	19.6	51		8
300	x	90	x	6	12000	22.0	45		6



Note: Some sizes may be subject to rolling MOQs.

Typical Uses:

- Residential Construction
- Non-Residential Construction
- Fabrication

Features:

- High strength roll-formed sections made from pre-coated strip of zinc, aluminium and magnesium
- Minimum coating of 250g/m² and self-healing properties
- Smooth quality finish
- Significantly lighter than traditional hot rolled sections
- Smooth surface allows easy powdercoating and painting
- Tensile strength minimum 450mPa

DuraGal® Angles

Unequal Angles

Dim 1		Dim 2		Nominal Thickness mm	Length	Mass kg/m	Metres per tonne
75	x	50	x	4	9000	3.73	268
75	x	50	x	5	9000	4.58	218
75	x	50	x	6	9000	5.46	183
90	x	75	x	6	9000	7.44	134
100	x	75	x	6	12000	7.87	127
125	x	75	x	5	12000	7.54	133
125	x	75	x	6	12000	9.08	110
150	x	100	x	6	12000	11.5	87

Typical Uses:

- Residential Construction
- Non-Residential Construction
- Fabrication

Features:

- High strength roll-formed sections made from pre-coated strip of zinc, aluminium and magnesium
- Minimum coating of 250g/m² and self-healing properties
- Smooth quality finish
- Significantly lighter than traditional hot rolled sections
- Smooth surface allows easy powdercoating and painting
- Tensile strength minimum 450mPa



Note: Some sizes may be subject to rolling MOQs.



Merchant Bar Processing

We can process Flats, Rounds and Angles using Beamlines, Band Saws, Croppers and Oxy Beveling Machines.

Applications include: Straight cuts, pack cuts, mitre cutting, drilling, notching, punching, shearing and cropping.

Call your local branch to discuss your requirements

DuraGal® Angles

Equal Angles

Dim 1		Dim 2		Nominal Thickness mm	Length	Mass kg/m	Metres per tonne	Length/Pack		
								Standard		
								6.0	9.0	12.0
25	x	25	x	2.5	6000	0.89	1119	80		
30	x	30	x	2.5	6000	1.09	915	80		
40	x	40	x	2.5	6000	1.49	671	60		
40	x	40	x	4.0	6000	2.31	433	39		
45	x	45	x	2.5	6000	1.69	592			
50	x	50	x	2.5	6000	1.89	530	33	33	
50	x	50	x	4.0	6000	2.94	340	27	27	
50	x	50	x	5.0	12000	3.59	278	24	24	24
50	x	50	x	6.0	9000	4.25	235		21	
65	x	65	x	4.0	9000	3.89	257		22	
65	x	65	x	5.0	9000	4.78	209		22	
65	x	65	x	6.0	9000	5.70	176		18	
75	x	75	x	4.0	9000	4.53	221		22	
75	x	75	x	5.0	6000	5.57	180	22	22	
75	x	75	x	6.0	9000	6.66	150		18	
90	x	90	x	5.0	9000	6.75	148		22	
90	x	90	x	6.0	9000	8.11	123			
100	x	100	x	6.0	12000	9.08	110			
150	x	150	x	6.0	12000	13.9	72			

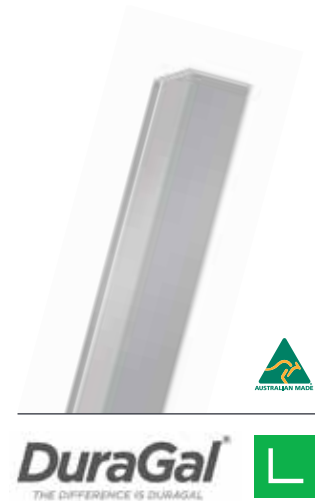

Note: Some sizes may be subject to rolling MOQs.

Typical Uses:

- Residential Construction
- Non-Residential Construction
- Fabrication

Features:

- High Strength roll-formed sections made from pre-coated strip of zinc, aluminium and magnesium
- Minimum coating of 250g/m² and self-healing properties
- Smooth quality finish
- Significantly lighter than traditional hot rolled sections
- Smooth surface allows easy powdercoating and painting
- Tensile strength minimum 450mPa

DuraGal® Flat Bars

Dim 1	Dim 2	Length	Mass kg/m	Metres per tonne	Length/Pack	
					Standard (m)	
					6.0	
50	x	4	6000	1.582	632	57
50	x	5	6000	1.975	506	45
65	x	5	6000	2.567	390	36
75	x	4	6000	2.373	421	38
75	x	5	6000	2.962	338	32
90	x	6	6000	4.346	230	26
100	x	4	6000	3.165	316	28
100	x	5	6000	3.950	253	28
100	x	6	6000	4.829	207	26
130	x	5	6000	5.134	195	28
150	x	5	6000	5.924	169	28
150	x	6	6000	7.243	138	24
200	x	5	6000	7.899	127	32
250	x	5	6000	9.874	101	23
300	x	5	6000	11.849	84	19



Note: some sizes may be subject to rolling MOQs.

Information reflects standard lengths as well as lengths available ex-rolling. Subject to MOQ.

Typical Uses:

- Residential Construction
- Non-Residential Construction
- Fabrication

Features:

- High strength roll-formed sections made from pre-coated strip of zinc, aluminium and magnesium
- Minimum coating of 250g/m² and self-healing properties
- Smooth quality finish
- Significantly lighter than traditional hot rolled sections
- Smooth surface allows easy powdercoating and painting
- Tensile strength minimum 450mPa

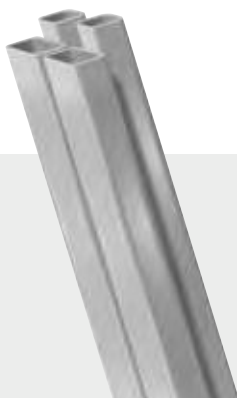

Tubular Processing

InfraBuild Steel Centre can process Pipe and Tube using a variety of machinery including Band Saws, Power Hacksaws, Tube saws and Beamlines.

Applications include: Straight cuts, pack cuts, drilling and de-burring.

Call your local branch to discuss your requirements

Square Hollow Sections (SHS)

Size mm × mm × mm	Surface Finish	Mass kg/m	Metres per tonne	Length/Pack	
				Standard (m)	
				6.5	8.0
25 x 25 x 1.6	P,S	1.12	890	100	
25 x 25 x 2.0	P,S	1.36	733	100	
25 x 25 x 2.5	P,S	1.64	610	100	
25 x 25 x 3.0	P,S	1.89	529	100	
30 x 30 x 1.6	P,S	1.38	727		100
30 x 30 x 2.0	P,S	1.68	596		100
30 x 30 x 2.5	P,S	2.03	492		100
30 x 30 x 3.0	P,S	2.36	423		64
35 x 35 x 1.6	P,S	1.63	615		100
35 x 35 x 2.0	P,S	1.99	502		100
35 x 35 x 2.5	P,S	2.42	412		64
35 x 35 x 3.0	P,S	2.83	353		64
40 x 40 x 1.6	P,S	1.88	533		81
40 x 40 x 2.0	P,S	2.31	434		81
40 x 40 x 2.5	P,S	2.82	355		64
40 x 40 x 3.0	P,S	3.30	303		64
40 x 40 x 4.0	P,S	4.09	244		49
50 x 50 x 1.6	P,S	2.38	420		64
50 x 50 x 2.0	P,S	2.93	300		64
50 x 50 x 2.5	P,S	3.60	278		49
50 x 50 x 3.0	P,S	4.25	236		49
50 x 50 x 4.0	P,S	5.35	187		36
50 x 50 x 5.0	P,S	6.39	156		30
50 x 50 x 6.0	O	7.32	137		25
65 x 65 x 1.6	P,S	3.13	319		49
65 x 65 x 2.0	P,S,C	3.88	258		42
65 x 65 x 2.5	P,S,C	4.78	209		42
65 x 65 x 3.0	P,S	5.66	177		36
65 x 65 x 4.0	P,S,C	7.23	138		30
65 x 65 x 5.0	P,S	8.75	114		25
65 x 65 x 6.0	P	10.1	98.6		20
75 x 75 x 2.0	P,S,C	4.50	222		36
75 x 75 x 2.5	P,S,C	5.56	180		30
75 x 75 x 3.0	P,S	6.60	152		30
75 x 75 x 3.5	P,S	7.53	133		25
75 x 75 x 4.0	P,S,C	8.49	118		25
75 x 75 x 5.0	P,S	10.3	96.9		20
75 x 75 x 6.0	P	12.0	83.1		16
89 x 89 x 2.0	S	5.38	186		20
89 x 89 x 3.5	P,S,C	9.07	110		20
89 x 89 x 5.0	P,S	12.5	80.0		16
89 x 89 x 6.0	P	14.7	68.3		12
90 x 90 x 2.0	Z	5.45	184		20



Surface Finishes:

- C** – DuraGal® Clear
- S** – DuraGal®
- Z** – DuraGal® ZB135/135
- P** – DuraPrimed®
- O** – Oiled

Typical Uses:

- Engineering Construction
- Residential Construction
- Non-Residential Construction
- Mining Investment
- Transport and Storage
- Manufacturing
- Agriculture

Features:

- Available in Grades C350L0 and C450PLUS™.
- All tube manufactured to meet AS/NZS 1163:2016
- Available in various coating types including DuraGal®, DuraGal® ZB135/135, DuraPrimed® and NOPC (No Oil or Paint Coating).
- DuraGal® hot-dip galvanized coating has a minimum average zinc mass of 100g/m².

Note: See page 27-28 for Rectangular Hollow Sections.

Square Hollow Sections (SHS)

Size mm x mm x mm	Surface Finish	Mass kg/m	Metres per tonne	Length/Pack	
				Standard (m)	
				8.0	12
100 x 100 x 2.0	P	6.07	165	20	20
100 x 100 x 2.5	P,S	7.53	133	20	
100 x 100 x 3.0	P,S,C	8.96	112	20	16
100 x 100 x 4.0	P,S	11.6	86.0	16	12
100 x 100 x 5.0	P,S,C	14.2	70.2	12	9
100 x 100 x 6.0	P	16.7	59.7	12	9
100 x 100 x 8.0	O	21.4	46.7	9	6
100 x 100 x 9.0	O	23.5	42.5	9	6
100 x 100 x 10.0	O	25.6	39.0		6
125 x 125 x 4.0	P	14.8	67.7	12	9
125 x 125 x 5.0	P	18.2	55.0	12	9
125 x 125 x 6.0	P	21.4	46.6	9	6
125 x 125 x 8.0	O	27.7	36.1	6	4
125 x 125 x 9.0	P,O	30.6	32.7	8	4
125 x 125 x 10.0	O	33.4	29.9		4
150 x 150 x 5.0	P	22.1	45.3	9	6
150 x 150 x 6.0	P	26.2	38.2	6	6
150 x 150 x 8.0	O	33.9	29.5	6	4
150 x 150 x 9.0	P,O	37.7	26.6	6	4
150 x 150 x 10.0	O	41.3	24.2		2
200 x 200 x 5.0	O	29.9	33.4	6	4
200 x 200 x 6.0	O	35.6	28.1	4	4
200 x 200 x 8.0	O	46.5	21.5	4	2
200 x 200 x 9.0	O	51.8	19.3	4	2
200 x 200 x 10.0	O	57.0	17.6		2
200 x 200 x 12.5	O	69.4	14.4		2
200 x 200 x 16.0	O	85.5	11.7		1
250 x 250 x 6.0	O	45.0	22.2	4	2
250 x 250 x 8.0	O	59.1	16.9	4	2
250 x 250 x 9.0	O	65.9	15.2	2	2
250 x 250 x 10.0	O	72.7	13.8		2
250 x 250 x 12.5	O	89.0	11.2		1
250 x 250 x 16.0	O	111	9.04		1
300 x 300 x 8.0	O	71.6	14.0		1
300 x 300 x 10.0	O	88.4	11.3		1
300 x 300 x 12.5	O	109	9.21		1
300 x 300 x 16.0	O	136	7.36		1
350 x 300 x 8.0	O	84.2	11.9		1
350 x 300 x 10.0	O	104	9.61		1
350 x 300 x 12.5	O	128	7.80		1
350 x 300 x 16.0	O	161	6.21		1
400 x 400 x 10.0	O	120	8.35		1
400 x 400 x 12.5	O	148	6.76		1
400 x 400 x 16.0	O	186	5.38		1



Surface Finishes:

- C** – DuraGal® Clear
- S** – DuraGal®
- Z** – DuraGal® ZB135/135
- P** – DuraPrimed®
- O** – Oiled

Typical Uses:

- Engineering Construction
- Residential Construction
- Non-Residential Construction
- Mining Investment
- Transport and Storage
- Manufacturing
- Agriculture

Features:

- Available in Grades C350L0 and C450PLUS™
- All tube manufactured to meet AS/NZS 1163:2016
- Available in various coating types including DuraGal®, DuraGal® ZB135/135, DuraPrimed® and NOPC (No Oil or Paint Coating).
- DuraGal® hot-dip galvanized coating has a minimum average zinc mass of 100g/m².

Note: See page 27-28 for Rectangular Hollow Sections.

Rectangular Hollow Sections (RHS)

Size mm x mm x mm	Surface Finish	Mass kg/m	Metres per tonne	Length/Pack	
				Standard (m)	
				8.0	12
50 x 25 x 1.6	P,S	1.75	571	96	
50 x 25 x 2.0	P,S	2.15	465	96	
50 x 25 x 2.5	P,S	2.62	382	72	
50 x 25 x 3.0	P,S	3.07	326	60	
65 x 35 x 2.0	P,S	2.93	341	54	
65 x 35 x 2.5	P,S	3.60	278	54	
65 x 35 x 3.0	P,S	4.25	236	45	
65 x 35 x 4.0	P,S	5.35	187	45	
75 x 25 x 1.6	P,S	2.38	420	65	
75 x 25 x 2.0	P,S	2.93	341	65	
75 x 25 x 2.5	P,S	3.60	278	48	
75 x 50 x 1.6	P,S,C	3.01	332	54	54
75 x 50 x 2.0	P,S	3.72	269	42	42
75 x 50 x 2.5	P,S	4.58	218	42	24
75 x 50 x 3.0	P,S	5.42	184	35	24
75 x 50 x 4.0	P,S	6.92	145	28	24
75 x 50 x 5.0	P,S	8.35	120	24	20
75 x 50 x 6.0	P	9.67	103	20	16
100 x 50 x 1.6	P,S,C,Z	3.64	275	32	32
100 x 50 x 2.0	P,S,C,Z	4.50	222	32	32
100 x 50 x 2.5	P,S	5.56	180	32	24
100 x 50 x 3.0	P,S	6.60	152	32	24
100 x 50 x 3.5	P,S	7.53	133	24	18
100 x 50 x 4.0	P,S	8.49	118	24	18
100 x 50 x 5.0	P,S	10.3	96.9	18	15
100 x 50 x 6.0	P	12.0	83.1	15	12
102 x 76 x 3.5	P,S	9.07	110	12	
102 x 76 x 5.0	P,S	12.5	79.9	12	
102 x 76 x 6.0	P,S	14.7	68.2	12	
125 x 75 x 2.0	P	6.07	165	24	
125 x 75 x 2.5	P,S	7.53	133	20	20
125 x 75 x 3.0	P,S	8.96	112	20	15
125 x 75 x 4.0	P,S	11.6	86.0	15	15
125 x 75 x 5.0	P,S	14.2	70.2	15	12
125 x 75 x 6.0	P	16.7	59.7	12	6
127 x 51 x 3.5	P	9.07	110	12	
127 x 51 x 5.0	P	12.5	79.9	8	
127 x 51 x 6.0	P	14.7	68.2	8	



Surface Finishes:

- C** – DuraGal® Clear
- S** – DuraGal®
- Z** – DuraGal® ZB135/135
- P** – DuraPrimed®
- O** – Oiled

Typical Uses:

- Engineering Construction
- Residential Construction
- Non-Residential Construction
- Mining Investment
- Transport and Storage
- Manufacturing
- Agriculture

Features:

- Available in Grades C350L0 and C450PLUS™
- All tube manufactured to meet AS/NZS 1163:2016
- Available in various coating types including DuraGal®, DuraGal® ZB135/135, DuraPrimed® and NOPC (No Oil or Paint Coating).
- DuraGal® hot-dip galvanized coating has a minimum average zinc mass of 100g/m².

Note: See page 25-26 for Square Hollow Sections

Rectangular Hollow Sections (RHS)

Size mm x mm x mm	Surface Finish	Mass kg/m	Metres per tonne	Length/Pack	
				Standard (m)	
				8.0	12
150 x 50 x 2.0	P,S,C,Z	6.07	165	21	21
150 x 50 x 2.5	P,S	7.53	133	24	18
150 x 50 x 3.0	P,S,C	8.96	112	21	15
150 x 50 x 4.0	P,S	11.6	86.0	15	15
150 x 50 x 5.0	P,S	14.2	70.2	15	9
150 x 50 x 6.0	P	16.7	59.7	15	9
150 x 100 x 4.0	P	14.8	67.7	12	9
150 x 100 x 5.0	P	18.2	55.0	12	8
150 x 100 x 6.0	P	21.4	46.6	9	6
150 x 100 x 8.0	O	27.7	36.1		4
150 x 100 x 9.0	O	30.6	32.7	6	4
152 x 76 x 5.0	O	16.4	60.7	8	8
152 x 76 x 6.0	O	19.4	51.5	8	8
200 x 100 x 4.0	P	17.9	55.8	8	6
200 x 100 x 5.0	P	22.1	45.3	8	6
200 x 100 x 6.0	P	26.2	38.2	8	4
200 x 100 x 8.0	O	33.9	29.5	6	4
200 x 100 x 9.0	O	37.7	26.6	6	4
250 x 150 x 5.0	O	29.9	33.4	6	4
250 x 150 x 6.0	O	35.6	28.1	4	4
250 x 150 x 8.0	O	46.5	21.5	4	2
250 x 150 x 9.0	O	51.8	19.3	4	2
250 x 150 x 10.0	O	57.0	17.6		2
250 x 150 x 12.5	O	69.4	14.4		1
250 x 150 x 16.0	O	85.5	11.7		1
300 x 200 x 6.0	O	45.0	22.2	2	1
300 x 200 x 8.0	O	59.1	16.9	2	1
300 x 200 x 9.0	O	65.9	15.2		2
300 x 200 x 10.0	O	72.7	13.8	1	1
300 x 200 x 12.5	O	89.0	11.2		1
300 x 200 x 16.0	O	111	9.04		1
350 x 250 x 8.0	O	71.6	14.0		2
350 x 250 x 10.0	O	88.4	11.3		1
350 x 250 x 12.5	O	109	9.21		1
350 x 250 x 16.0	O	136	7.36		1
400 x 200 x 8.0	O	71.6	14.0		2
400 x 200 x 10.0	O	88.4	11.3		1
400 x 200 x 12.5	O	109	9.21		1
400 x 200 x 16.0	O	136	7.36		1
400 x 300 x 8.0	O	84.2	11.9		1
400 x 300 x 10.0	O	104	9.61		1
400 x 300 x 12.5	O	128	7.80		1
400 x 300 x 16.0	O	161	6.21		1



Surface Finishes:

- C** – DuraGal® Clear
- S** – DuraGal®
- Z** – DuraGal® ZB135/135
- P** – DuraPrimed®
- O** – Oiled

Typical Uses:

- Engineering Construction
- Residential Construction
- Non-Residential Construction
- Mining Investment
- Transport and Storage
- Manufacturing
- Agriculture

Features:

- Available in Grades C350L0 and C450PLUS™
- All tube manufactured to meet AS/NZS 1163:2016
- Available in various coating types including DuraGal®, DuraGal® ZB135/135, DuraPrimed® and NOPC (No Oil or Paint Coating).
- DuraGal® hot-dip galvanized coating has a minimum average zinc mass of 100g/m².

Note: See page 25-26 for Square Hollow Sections.

Information reflects standard lengths as well as lengths available ex-rolling. Subject to MOQ.

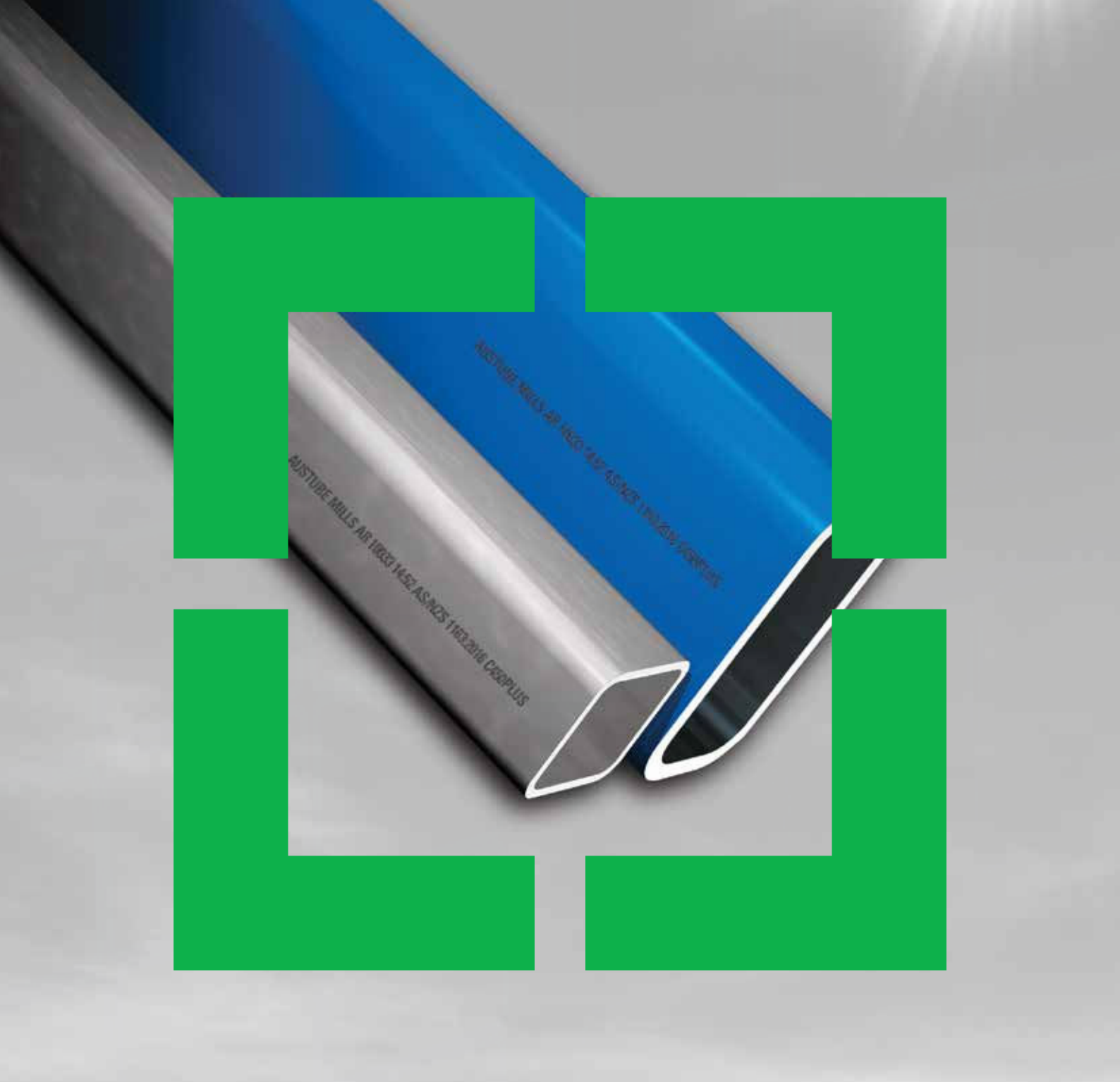

Higher strength and more efficient structural steel - C450PLUS™

C450PLUS™ is a unique dual-grade tubular section offering the strength of 450-grade steel with the elongation, formability and weldability of 350-grade.

Available in all sizes of SHS and RHS, with coating options including DuraGal®, DuraPrimed® and oiled.

Stock Rail and Posts

Stock Rail Sections				
Designation d x b mm	Wall Thickness mm	Mass kg/m	Metres per tonne	Pack Size (Lns)
53 x 35	1.6	1.77	565	48
60 x 48	2.0	2.88	347	36
66 x 44	1.6	2.23	448	36
75 x 40	1.6	2.39	418	20
75 x 40	2.0	2.97	337	20
97 x 40	2.0	3.65	274	21
115 x 42	2.0	4.27	234	21
115 x 42	2.5	5.30	189	21
120 x 48	2.0	4.53	221	18

Note: Some sizes subject to rolling MOQs.

Post Sections				
Designation d x b mm	Wall Thickness mm	Mass kg/m	Metres per tonne	Pack Size (Lns)
40 x 40	1.6	1.88	532	81
40 x 40	2.0	2.31	433	81
50 x 50	1.6	2.38	420	64
50 x 50	2.0	2.93	341	64
75 x 75	4.0	8.49	118	25
100 x 100	4.0	11.6	86	16

Silo Sections

DuraPrimed®, DuraGal®				
Designation d x b mm	Wall Thickness mm	Mass kg/m	Metres per tonne	Pack Size (Lns)
75 x 64	2.5	4.75	211	36
75 x 64	3.0	5.56	180	24

Note: DuraPrimed® replaces Painted.



Features:



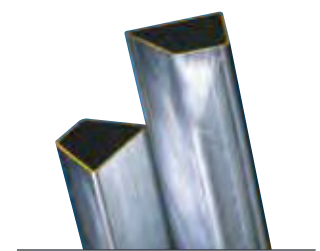



- Coated in DuraGal® for superior corrosion protection
- All tube manufactured to meet AS/NZS 1163:2016
- Smooth elongated edges minimise risk of bruising and injury to livestock
- Lightweight, easy to handle and transport
- Flat sides allow for easy connectivity
- Minimal weld spatter or fumes



Features:

- Available in DuraPrimed® and DuraGal®
- All tube manufactured to meet AS/NZS 1163:2016

Stock Rail Accessories

Product Image	Product Name	Product Code	Weight (kg/EA)	Box Quantity
	Cattle Rail Joiner	VRH115	0.50	30
	Cattle Rail Zinc Cap	VRH115C	0.10	50
	Cattle Rail Clip	VRH115CLIP	0.10	60
	Cattle Rail End Joiner	VRH115EJ	0.50	30
	Cattle Rail Hanger Double End	VCATTLECR	0.75	24
	Cattle Rail Hanger Single	VCATTLECRH	0.35	48
	Cattle Rail Plastic End Cap	VACEPC01154	0.09	125

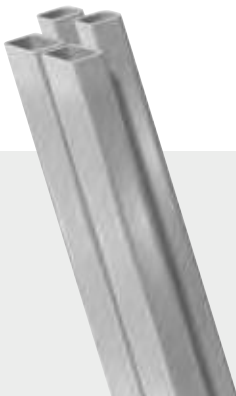

Tubular Processing

InfraBuild Steel Centre can process Pipe and Tube using a variety of machinery including Band Saws, Power Hacksaws, Tube saws and Beamlines.

Applications include: Straight cuts, pack cuts, drilling and de-burring.

Call your local branch to discuss your requirements

Circular Hollow Sections (CHS)

Availability Overview

Nominal Size (DN)	Section	Outside Diameter mm	Wall Thickness mm	Black	Oiled C350L0	DuraPrimed Red™	DuraGal®	DuraGal® ZB135/135	Hot-dip Galv
25	Extra Light	33.7	2.0	✓			✓		
25	Light	33.7	2.6	✓			✓		
25	Medium	33.7	3.2	✓		✓	✓	✓	
25	Heavy	33.7	4.0						
32	Extra Light	42.4	2.0	✓			✓		
32	Light	42.4	2.6	✓			✓		
32	Medium	42.4	3.2	✓		✓	✓	✓	
32	Heavy	42.4	4.0						
40	Extra Light	48.3	2.3	✓			✓		
40	Light	48.3	2.9	✓			✓		
40	Medium	48.3	3.2	✓		✓	✓	✓	
40	Heavy	48.3	4.0	✓					✓
40	Extra Heavy	48.3	5.4						
50	Extra Light	60.3	2.3	✓			✓		
50	Light	60.3	2.9	✓			✓		
50	Medium	60.3	3.6	✓		✓	✓		✓
50	Heavy	60.3	4.5	✓					✓
50	Extra Heavy	60.3	5.4						
65	Extra Light	76.1	2.3	✓			✓		
65	Light	76.1	3.2	✓			✓		
65	Medium	76.1	3.6	✓		✓	✓		✓
65	Heavy	76.1	4.5						✓
65	Extra Heavy	76.1	5.9	✓					
80	Extra Light	88.9	2.6	✓			✓		✓
80	Light	88.9	3.2	✓			✓		✓
80	Medium	88.9	4.0	✓		✓	✓		✓
80	Heavy	88.9	5.0	✓					✓
80	Extra Heavy	88.9	5.9						
90	Extra Light	101.6	2.6	✓					✓
90	Light	101.6	3.2	✓					✓
90	Medium	101.6	4.0	✓		✓			✓
90	Heavy	101.6	5.0						
100	Extra Light	114.3	3.2	✓					✓
100	Light	114.3	3.6	✓					✓
100	Medium	114.3	4.5	✓		✓			✓
100	Heavy	114.3	5.4						
125	Extra Light	139.7	3.0		✓				✓
125	Light	139.7	3.5		✓				✓
125	Medium	139.7	5.0		✓				✓
125	Heavy	139.7	5.4						
150	Extra Light	165.1	3.0		✓				✓
150	Light	165.1	3.5		✓				✓
150	Medium	165.1	5.0		✓				✓
150	Heavy	165.1	5.4		✓				✓

Note: Some sizes subject to rolling MOQs.

Note: InfraBuild Steel Centre reserve the right to change specifications without notice. Not all products are available at all InfraBuild Steel Centre branches. InfraBuild Steel Centre also has access to a wide network of products not necessarily listed in this book. Please check with your local InfraBuild Steel Centre branch for product availability.

Circular Hollow Sections (CHS)

Black

Nominal Size (DN)	Section	Outside Diameter mm	Wall Thickness mm	Mass kg/m	Metres per tonne	Pack Size (Lns)
25	Extra Light	33.7	2.0	1.56	641	91
25	Light		2.6	1.99	503	91
25	Medium		3.2	2.41	415	91
25	Heavy		4.0	2.94	340	91
32	Extra Light	42.4	2.0	1.99	503	61
32	Light		2.6	2.55	392	61
32	Medium		3.2	3.10	323	61
32	Heavy		4.0	3.80	263	61
40	Extra Light	48.3	2.3	2.61	383	61
40	Light		2.9	3.25	308	61
40	Medium		3.2	3.57	280	61
40	Heavy		4.0	4.38	228	61
40	Extra Heavy		5.4	5.71	175	61
50	Extra Light	60.3	2.3	3.29	304	37
50	Light		2.9	4.11	243	37
50	Medium		3.6	5.03	199	37
50	Heavy		4.5	6.19	162	37
50	Extra Heavy		5.4	7.31	137	37
65	Extra Light	76.1	2.3	4.19	239	37
65	Light		3.2	5.75	174	37
65	Medium		3.6	6.43	156	37
65	Heavy		4.5	7.93	126	37
65	Extra Heavy		5.9	10.2	97	37
80	Extra Light	88.9	2.6	5.53	181	19
80	Light		3.2	6.76	148	19
80	Medium		4.0	8.37	119	19
80	Heavy		5.0	10.3	97	19
80	Extra Heavy		5.9	12.1	83	19
90	Extra Light	101.6	2.6	6.35	157	19
90	Light		3.2	7.77	129	19
90	Medium		4.0	9.63	104	19
90	Heavy		5.0	11.9	84	19
100	Extra Light	114.3	3.2	8.77	114	19
100	Light		3.6	9.83	102	19
100	Medium		4.5	12.2	82	19
100	Heavy		5.4	14.5	69	19
125	Extra Light	139.7	3.0	10.1	99	13
125	Light		3.5	11.8	85	13
125	Medium		5.0	16.6	60	13
125	Heavy		5.4	17.9	56	13
150	Extra Light	165.1	3.0	12.0	83	10
150	Light		3.5	13.9	72	10
150	Medium		5.0	19.7	51	10
150	Heavy		5.4	21.3	47	10



DuraGal Clear™

Typical Uses:

- Engineering Construction
- Residential Construction
- Non-Residential Construction
- Mining Investment
- Transport and Storage
- Manufacturing
- Agriculture

Features:

- Extra Light and Light sections meet AS/NZS 1163: 2016 C350L0
- Medium and Heavy sections meet AS 1074 & AS/NZS 1163 - C250

Circular Hollow Sections (CHS)

DuraGal®

Nominal Size (DN)	Section	Outside Diameter mm	Wall Thickness mm	Mass kg/m	Metres per tonne	Pack Size (Lns)
25	Extra Light	33.7	2.0	1.56	641	91
25	Light		2.6	1.99	503	91
25	Medium		3.2	2.41	415	91
32	Extra Light	42.4	2.0	1.99	503	61
32	Light		2.6	2.55	392	61
32	Medium		3.2	3.10	323	61
40	Extra Light	48.3	2.3	2.61	383	61
40	Light		2.9	3.25	308	61
40	Medium		3.2	3.57	280	61
50	Extra Light	60.3	2.3	3.29	304	37
50	Light		2.9	4.11	243	37
50	Medium		3.6	5.03	199	37
65	Extra Light	76.1	2.3	4.19	239	37
65	Light		3.2	5.75	174	37
65	Medium		3.6	6.43	156	37
80	Extra Light	88.9	2.6	5.53	181	19
80	Light		3.2	6.76	148	19
80	Medium		4.0	8.37	119	19
90	Light	101.6	3.2	7.77	129	19
90	Medium		4.0	9.63	104	19
100	Light	114.3	3.6	9.83	102	19
100	Medium		4.5	12.20	82	19

Available off mill rolling only. Minimum order quantity required.

Circular Hollow Sections (CHS)

DuraPrimed Red™

Nominal Size (DN)	Section	Outside Diameter mm	Wall Thickness mm	Mass kg/m	Metres per tonne	Pack Size (Lns)
25	Medium	33.7	3.2	2.41	414	91
32	Medium	42.4	3.2	3.10	322	61
40	Medium	48.3	3.2	3.57	280	61
50	Medium	60.3	3.6	5.03	199	37
65	Medium	76.1	3.6	6.43	156	37
80	Medium	88.9	4.0	8.37	120	19
100	Medium	114.3	4.5	12.2	82.2	19

Typical Uses:

- Fire System Tube

Features:

- Dual Specified AS 1074 and AS/NZS 1163 C250L0
- Available in plain ends, screwed one end and screwed both ends

Note: InfraBuild Steel Centre reserve the right to change specifications without notice. Not all products are available at all InfraBuild Steel Centre branches. InfraBuild Steel Centre also has access to a wide network of products not necessarily listed in this book. Please check with your local InfraBuild Steel Centre branch for product availability.



DuraGal
THE DIFFERENCE IS DURABLE.

Typical Uses:

- Engineering Construction
- Residential Construction
- Non-Residential Construction
- Mining Investment
- Transport and Storage
- Manufacturing
- Agriculture

Features:

- Medium Dual Specified AS 1074 / AS/NZS 1163 C250L0
- Extra Light and Light AS/NZS 1163: 2016 C350L0
- DuraGal coating AS/NZS 4792: 2006 ZB100/100



Circular Hollow Sections (CHS)

Hot-dip Galvanised

Nominal Size (DN)	Section	Outside Diameter mm	Wall Thickness mm	Mass kg/m	Metres per tonne	Pack Size (Lns)
32	Heavy	42.4	4.0	3.87	258	61
40	Heavy	48.3	4.0	4.46	224	61
50	Medium	60.3	3.6	5.14	195	37
50	Heavy	60.3	4.5	6.30	159	37
65	Medium	76.1	3.6	6.56	152	37
65	Heavy	76.1	4.5	8.07	124	37
80	Extra Light	88.9	2.6	5.75	174	19
80	Light	88.9	3.2	6.92	145	19
80	Medium	88.9	4.0	8.53	117	19
80	Heavy	88.9	5.0	10.50	95	19
90	Extra Light	101.6	2.6	6.64	151	19
90	Light	101.6	3.2	8.02	125	19
90	Medium	101.6	4.0	9.81	102	19
90	Heavy	101.6	5.0	12.10	83	19
100	Extra Light	114.3	3.2	9.05	110	19
100	Light	114.3	3.6	10.00	100	19
100	Medium	114.3	4.5	12.40	81	19
100	Heavy	114.3	5.4	14.70	68	19
125	Extra Light	139.7	3.0	10.50	95	10
125	Light	139.7	3.5	12.10	83	10
125	Medium	139.7	5.0	16.90	59	10
125	Heavy	139.7	5.4	18.10	55	10
150	Extra Light	165.1	3.0	12.40	81	10
150	Light		3.5	14.40	69	10
150	Medium		5.0	20.00	50	10
150	Heavy		5.4	21.60	46	10



Typical Uses:

- Engineering Construction
- Residential Construction
- Non-Residential Construction
- Mining Investment
- Transport and Storage
- Manufacturing
- Agriculture

Features:

- Medium and Heavy Dual Specified AS 1074 and AS/NZS 1163 C250L0
- Extra Light and Light AS/NZS 1163 C350L0
- Hot Dip Galvanized AS/NZS 4680: 2006 HDG 300

Structural CHS

Size d x t mm	Mass kg/m
60.3 x 4.0	5.42
60.3 x 4.8	6.50
60.3 x 5.2	7.02
76.1 x 4.0	
76.1 x 4.8	
76.1 x 5.2	
76.1 x 5.5	
76.1 x 5.7	
76.1 x 6.0	
76.1 x 6.4	
76.1 x 6.6	
76.1 x 7.1	
88.9 x 4.0	8.37
88.9 x 4.8	10.5
88.9 x 5.2	
88.9 x 5.5	11.3
88.9 x 5.7	
88.9 x 6.0	
88.9 x 6.4	
88.9 x 6.6	
88.9 x 7.6	15.2
101.6 x 4.0	
101.6 x 4.8	
101.6 x 5.2	
101.6 x 5.5	
101.6 x 5.7	13.5
101.6 x 6.0	
101.6 x 6.4	
101.6 x 6.6	
101.6 x 7.1	
101.6 x 8.2	18.7
114.3 x 4.0	11.3
114.3 x 4.8	13.0
114.3 x 5.2	
114.3 x 5.5	
114.3 x 5.7	
114.3 x 6.0	16.0
114.3 x 6.4	
114.3 x 6.6	
114.3 x 7.1	
114.3 x 8.2	
114.3 x 8.6	22.4
141.3 x 4.0	
141.3 x 4.8	16.16
141.3 x 5.2	
141.3 x 5.5	
141.3 x 5.7	
141.3 x 6.0	
141.3 x 6.4	
141.3 x 6.6	21.9

Size d x t mm	Mass kg/m
141.3 x 7.1	
141.3 x 8.2	
141.3 x 8.6	
141.3 x 9.3	
141.3 x 9.5	30.9
168.3 x 4.0	16.2
168.3 x 4.8	19.4
168.3 x 5.2	
168.3 x 5.5	
168.3 x 5.7	
168.3 x 6.0	
168.3 x 6.4	25.5
168.3 x 6.6	
168.3 x 7.1	28.2
168.3 x 8.2	33.1
168.3 x 8.6	
168.3 x 9.3	
168.3 x 9.5	38.3
168.3 x 11.0	42.6
219.1 x 4.0	21.2
219.1 x 4.8	25.4
219.1 x 5.2	
219.1 x 5.5	29.0
219.1 x 5.7	
219.1 x 6.0	
219.1 x 6.4	33.6
219.1 x 6.6	
219.1 x 7.1	38.4
219.1 x 8.2	42.6
219.1 x 8.6	
219.1 x 9.3	
219.1 x 9.5	
219.1 x 11.0	
219.1 x 12.7	64.6
273.1 x 4.0	
273.1 x 4.8	31.8
273.1 x 5.2	34.1
273.1 x 5.5	36.2
273.1 x 5.7	
273.1 x 6.0	42.1
273.1 x 6.4	42.1
273.1 x 6.6	
273.1 x 7.1	
273.1 x 8.2	
273.1 x 8.6	
273.1 x 9.3	60.50
273.1 x 9.5	
273.1 x 11.0	
273.1 x 12.7	81.60
273.1 x 14.0	

Size d x t mm	Mass kg/m
273.1 x 15.1	
323.9 x 4.0	
323.9 x 4.8	37.8
323.9 x 5.2	
323.9 x 5.5	43.1
323.9 x 5.7	
323.9 x 6.0	
323.9 x 6.4	50.1
323.9 x 6.6	
323.9 x 7.1	55.0
323.9 x 8.2	64.2
323.9 x 8.6	66.9
323.9 x 9.3	
323.9 x 9.5	73.7
323.9 x 11.0	85.6
323.9 x 12.7	97.5
323.9 x 14.0	108
323.9 x 15.1	
323.9 x 16.0	
355.6 x 4.25	
355.6 x 4.8	
355.6 x 5.2	
355.6 x 5.5	
355.6 x 5.7	
355.6 x 6.0	
355.6 x 6.4	55.1
355.6 x 6.6	
355.6 x 7.1	
355.6 x 8.2	
355.6 x 8.6	
355.6 x 9.3	
355.6 x 9.5	81.1
355.6 x 11.0	
355.6 x 12.7	107
355.6 x 14.0	
355.6 x 15.1	
355.6 x 16.0	
355.6 x 17.0	
406.4 x 4.25	
406.4 x 4.8	
406.4 x 5.2	
406.4 x 5.5	
406.4 x 5.7	
406.4 x 6.0	
406.4 x 6.4	63.1
406.4 x 6.6	
406.4 x 7.1	
406.4 x 8.2	
406.4 x 8.6	
406.4 x 9.3	



Features:

- Dual Grade API 5L B/X42 and AS/NZS 1163: 2016 C350L0

Structural CHS

Size d x t mm	Mass kg/m
406.4 x 9.5	93.0
406.4 x 11.0	
406.4 x 12.7	123
406.4 x 14.0	
406.4 x 15.1	
406.4 x 16.0	
406.4 x 17.0	
457.0 x 4.8	
457.0 x 5.2	
457.0 x 5.5	
457.0 x 5.7	
457.0 x 6.0	
457.0 x 6.4	71.1
457.0 x 6.6	
457.0 x 7.1	
457.0 x 8.2	
457.0 x 8.6	
457.0 x 9.3	
457.0 x 9.5	105
457.0 x 11.0	
457.0 x 12.7	139
457.0 x 14.0	
457.0 x 15.1	
457.0 x 16.0	
457.0 x 17.0	
508.0 x 5.5	
508.0 x 5.7	

Size d x t mm	Mass kg/m
508.0 x 6.0	
508.0 x 6.4	79.2
508.0 x 6.6	
508.0 x 7.1	
508.0 x 8.2	
508.0 x 8.6	
508.0 x 9.3	
508.0 x 9.5	117
508.0 x 11.0	
508.0 x 12.7	155
508.0 x 14.0	
508.0 x 15.1	
508.0 x 16.0	
508.0 x 17.0	
508.0 x 19.0	
610 x 6.0	
610 x 6.4	
610 x 6.6	
610 x 7.1	
610 x 8.2	
610 x 8.6	
610 x 9.3	
610 x 9.5	
610 x 11.0	
610 x 12.7	
610 x 14.0	
610 x 15.1	

Size d x t mm	Mass kg/m
610 x 16.0	
610 x 17.0	
610 x 19.0	
660 x 6.0	
660 x 6.4	
660 x 6.6	
660 x 7.1	
660 x 8.2	
660 x 8.6	
660 x 9.3	
660 x 9.5	
660 x 11.0	
660 x 12.7	
660 x 14.0	
660 x 15.1	
660 x 16.0	
660 x 17.0	
660 x 19.0	



Features:

- Dual Grade API 5L B/X42 and AS/NZS 1163 C350L0

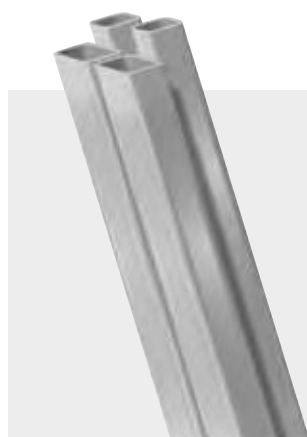

Peace of Mind With DuraGal®

Given the diverse climate and geography of the Australian landscape, only a DuraGal® coating can give you the peace of mind that you have the protection you need for the job at hand. DuraGal® can be used in a variety of residential construction applications such as roof trusses, fencing, verandahs, elevated flooring solutions and shade structures. It is also commonly applied across a variety of other sectors including mining, commercial, engineering, manufacturing, agriculture and transport.



Call your local branch to discuss your requirements

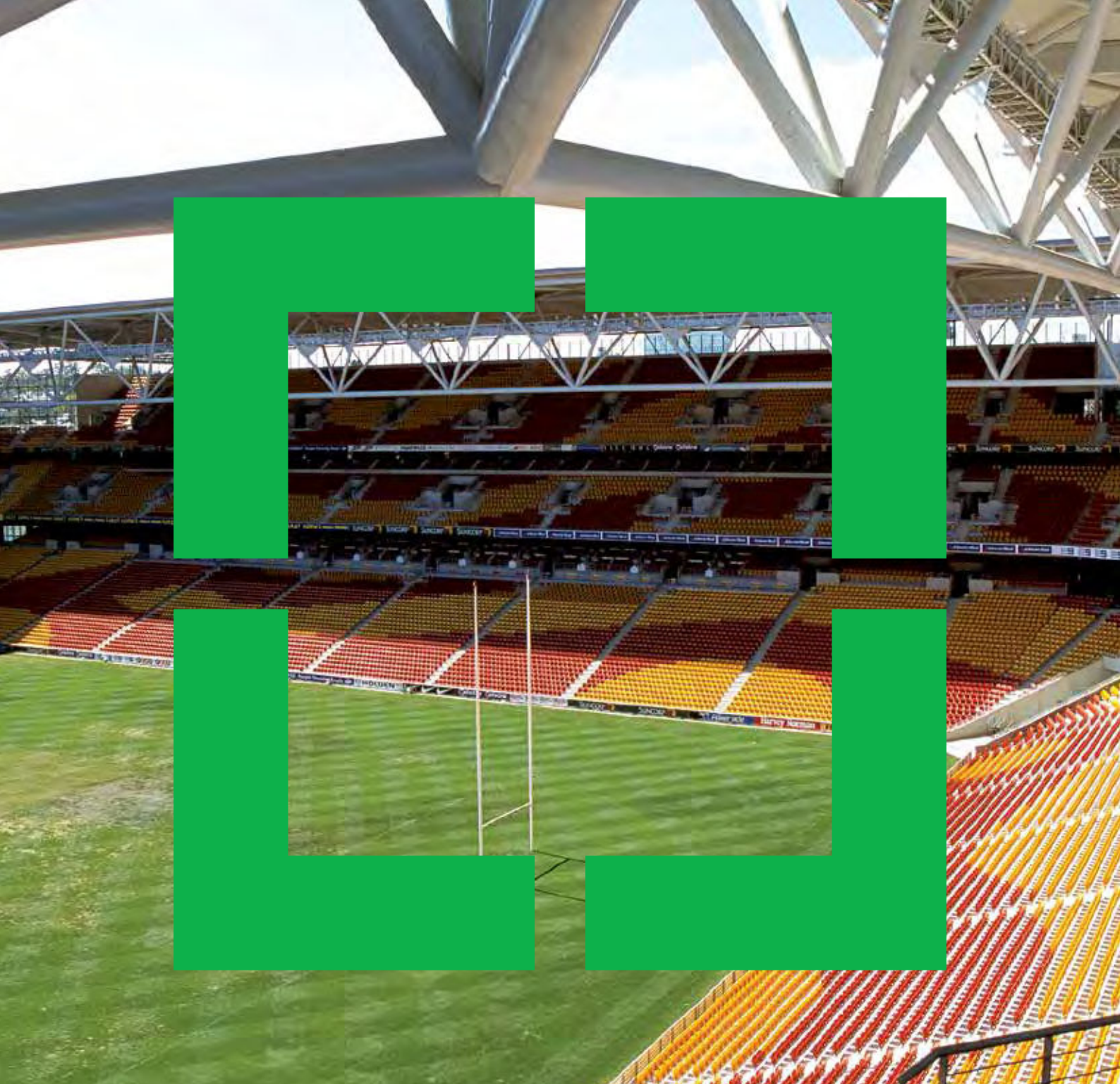

Processing Capabilities

InfraBuild Steel Centre's national network of branches gives you access to an expansive range of processing solutions combined with a large range of products, project management and technical expertise.

InfraBuild Steel Centre's comprehensive range of in-house processing equipment and proven experience will assist you in reducing risk on your projects whilst maximising the quality of results.

Telescoping RHS

Rectangular Hollow Sections

Female (Outer)			Nominal Clearance		Male (Inner)	
d mm	b mm	t mm	Top mm	Side mm	d mm	b mm
50	20	1.6				
50	20	2.0				
50	20	2.5			No section available	
50	20	3.0				
50	25	1.6				
50	25	2.0				
50	25	2.5			No section available	
50	25	3.0				
65	35	2.0	11.0	6.00	50	25
65	35	2.5	10.0	5.00	50	25
65	35	3.0	9.00	4.00	50	25
65	35	4.0	7.00	2.00	50	25
75	25	1.6	21.8	1.80	50	20
75	25	2.0	21.0	1.00	50	20
75	25	2.5	20.0	0.00	50	20
75	50	1.6	6.80	11.8	65	35
75	50	2.0	6.00	11.0	65	35
75	50	2.5	5.00	10.0	65	35
75	50	3.0	4.00	9.00	65	35
75	50	4.0	2.00	7.00	65	35
75	50	5.0	0.00	5.00	65	35
75	50	6.0	13.0	13.0	50	25
100	50	1.6	20.8	20.8	76	38
100	50	2.0	20.0	20.0	76	38
100	50	2.5	19.0	19.0	76	38
100	50	3.0	18.0	18.0	76	38
100	50	3.5	17.0	17.0	76	38
100	50	4.0	16.0	16.0	76	38
100	50	5.0	14.0	14.0	76	38
100	50	6.0	12.0	12.0	76	38
125	75	2.0	21.0	21.0	100	50
125	75	2.5	20.0	20.0	100	50
125	75	3.0	19.0	19.0	100	50
125	75	4.0	17.0	17.0	100	50
125	75	5.0	15.0	15.0	100	50
125	75	6.0	13.0	13.0	100	50
200	100	4.0	40.0	40.0	152	76
200	100	5.0	38.0	38.0	152	76
200	100	6.0	36.0	36.0	152	76
200	100	9.0	30.0	30.0	152	76
250	150	5.0	40.0	40.0	200	100
250	150	6.0	38.0	38.0	200	100
250	150	9.0	32.0	32.0	200	100

AVAILABLE WA ONLY

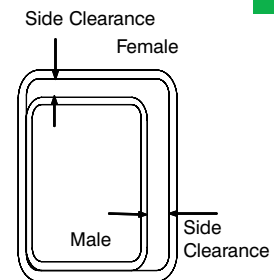

Note: RHS is not a precision tube and all dimensions shown in the chart, although in accordance with the specifications, may vary marginally within the tolerance bands permitted.

Sizes shown in bold print are sizes that provide a clearance of less than 2.0mm. The internal weld bead and variation in corner radii between sections will need to be considered when closer fits are indicated. Where telescoping over some length is desired, additional allowance may be needed for straightness. For tight fits it is suggested that some form of testing be carried out prior to committing material.

How to use this chart
See page 41

Note: See page 34 for Circular Hollow Sections and 25 for Square Hollow Sections.

Telescoping SHS

Square Hollow Sections

Female (Outer)			Nominal Clearance		Male (Inner)	
d mm	b mm	t mm	Top mm	Side mm	d mm	b mm
20	20	1.6	1.8	1.8		
25	25	1.6	1.8	1.8	20	20
25	25	2.0	1.0	1.0	20	20
25	25	2.5	0.0	0.0	20	20
30	30	1.6	1.8	1.8	25	25
30	30	2.0	1.0	1.0	25	25
35	35	1.6	1.8	1.8	30	30
35	35	2.0	1.0	1.0	30	30
35	35	2.5	0.0	0.0	30	30
35	35	3.0	4.0	4.0	25	25
40	40	1.6	1.8	1.8	35	35
40	40	2.0	1.0	1.0	35	35
40	40	2.5	0.0	0.0	35	35
40	40	3.0	4.0	4.0	30	30
40	40	4.0	2.0	2.0	30	30
50	50	1.6	6.8	6.8	40	40
50	50	2.0	6.0	6.0	40	40
50	50	2.5	5.0	5.0	40	40
50	50	3.0	4.0	4.0	40	40
50	50	4.0	2.0	2.0	40	40
50	50	5.0	0.0	0.0	40	40
65	65	1.6	11.8	11.8	50	50
65	65	2.0	11.0	11.0	50	50
65	65	2.5	10.0	10.0	50	50
65	65	3.0	9.0	9.0	50	50
65	65	4.0	7.0	7.0	50	50
65	65	5.0	5.0	5.0	50	50
65	65	6.0	3.0	3.0	50	50
75	75	2.0	6.0	6.0	65	65
75	75	2.5	5.0	5.0	65	65
75	75	3.0	4.0	4.0	65	65
75	75	3.5	3.0	3.0	65	65
75	75	4.0	2.0	2.0	65	65
75	75	5.0	0.0	0.0	65	65
75	75	6.0	13.0	13.0	50	50
89	89	3.5	7.0	7.0	75	75
89	89	5.0	4.0	4.0	75	75
89	89	6.0	2.0	2.0	75	75
90	90	2.0	11.0	11.0	75	75
90	90	2.5	10.0	10.0	75	75
100	100	2.0	7.1	7.1	89	89
100	100	2.5	6.1	6.1	89	89
100	100	3.0	5.1	5.1	89	89
100	100	4.0	3.1	3.1	89	89
100	100	5.0	1.1	1.1	89	89
100	100	6.0	13.0	13.0	75	75
100	100	9.0	7.0	7.0	75	75
125	125	4.0	17.0	17.0	100	100
125	125	5.0	15.0	15.0	100	100

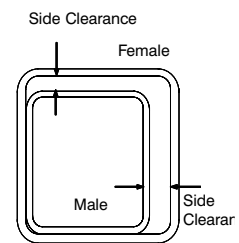

Note: SHS is not a precision tube and all dimensions shown in the chart, although in accordance with the specifications, may vary marginally within the tolerance bands permitted.

Sizes shown in bold print are sizes that provide a clearance of less than 2.0mm. The internal weld bead and variation in corner radii between sections will need to be considered when closer fits are indicated. Where telescoping over some length is desired, additional allowance may be needed for straightness. For tight fits it is suggested that some form of testing be carried out prior to committing material.

How to use this chart
See page 41

Note: See page 34 for Circular Hollow Sections and 27 for Rectangular Hollow Sections.

Telescoping SHS

Square Hollow Sections

Female (Outer)			Nominal Clearance		Male (Inner)	
d mm	b mm	t mm	Top mm	Side mm	d mm	b mm
125	125	6.0	13.0	13.0	100	100
125	125	9.0	7.0	7.0	100	100
150	150	5.0	15.0	15.0	125	125
150	150	6.0	13.0	13.0	125	125
150	150	9.0	7.0	7.0	125	125
200	200	5.0	40.0	40.0	150	150
200	200	6.0	38.0	38.0	150	150
200	200	9.0	32.0	32.0	150	150
250	250	6.0	38.0	38.0	200	200
250	250	9.0	32.0	32.0	200	200



How to use this chart

1. Select the appropriate table for the type of hollow section required. Select the size of female (or outside) member closest to your requirements for the left hand column.
2. Depending on the application select the clearance required between the two members. Members may need to slide freely inside each other, or be locked with a pin, spot welded or fixed with wedges. This means, in some cases, a 'sloppy' fit may be suitable, while for others the tightest fit possible may be more appropriate.
3. Having selected the most suitable clearance for your application, take the appropriate size of the male (inner) section from the right hand column, eg:
 - Female Section (outer) 75 x 75 x 3.0
 - Clearance mm 4.0x4.0
 - Male Section (inner) 65 x 65
4. Where two telescoping sections are being used, thickness should be similar and will be determined by normal structural requirements. If a third section is to be used, consideration of both clearance and thickness within the size list available may be required.
5. RHS has the obvious advantage that its shape prevents rotation of the sections. When pipe is used it may need to be fixed against twisting by welding or bolting.
6. Press Fit. For short pieces with no need for separation or sliding an interference fit can be achieved using the available ductility of the steel.

Note: Sizes where clearance is shown as 0.0 will generally require press fit.

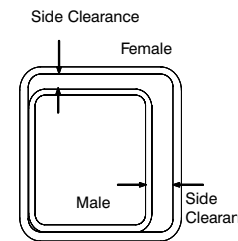

Note: SHS is not a precision tube and all dimensions shown in the chart, although in accordance with the specifications, may vary marginally within the tolerance bands permitted.

Sizes shown in bold print are sizes that provide a clearance of less than 2.0mm. The internal weld bead and variation in corner radii between sections will need to be considered when closer fits are indicated. Where telescoping over some length is desired, additional allowance may be needed for straightness. For tight fits it is suggested that some form of testing be carried out prior to committing material.

Note: See page 34 for Circular Hollow Sections and 27 for Rectangular Hollow Sections.

Note: Clearance is total available difference between member dimensions, not the gap on both sides.

Telescoping CHS

Circular Hollow Sections

How to use this chart

1. Select the size of female (or outside) member closest to your requirements for the left hand column.
2. Depending on the application select the clearance required between the two members. Members may need to slide freely inside each other, or be locked with a pin, spot welded or fixed with wedges. This means, in some cases, a 'sloppy' fit may be suitable, while for others the tightest fit possible may be more appropriate. (See Note 6 Press Fit).
3. Having selected the most suitable clearance for your application, take the appropriate size of the male (inner) section from the right hand column, eg:
 - Female Section (outer) 76.1 x 5.9
 - Clearance mm 2.6
 - Male Section (inner) 60.3
4. Where two telescoping sections are being used, thickness should be similar and will be determined by normal structural requirements. If a third section is to be used, consideration of both clearance and thickness within the size list available may be required.
5. Pipe may need to be fixed against twisting by welding or bolting.
6. Press Fit. For short pieces with no need for separation or sliding an interference fit can be achieved using the available ductility of the steel.

Note: Sizes where clearance is shown as 0.0 will generally require press fit.

Note: Clearance is total available difference between member dimensions, not the gap on both sides.

Female (Outer)			Male (Inner)		
DN	Quality	do t mm x mm	DN	di mm	Min. Clearance mm
20	Extra LIght	26.9 x 2.0	15	21.3	0.4
25	Extra Light	33.7 x 2.0	20	26.9	1.6
25	Light	33.7 x 2.6	20	26.9	0.4
25	Medium	33.7 x 3.2	15	21.3	4.8
25	Heavy	33.7 x 4.0	15	21.3	3.2
32	Extra Light	42.4 x 2.0	25	33.7	3.5
32	Light	42.4 x 2.6	25	33.7	2.3
32	Medium	42.4 x 3.2	25	33.7	1.1
32	Heavy	42.4 x 4.0	20	26.9	6.3
40	Extra Light	48.3 x 2.3	32	42.4	0.1
40	Light	48.3 x 2.9	25	33.7	7.6
40	Medium	48.3 x 3.2	25	33.7	7.0
40	Heavy	48.3 x 4.0	25	33.7	5.4
40	Extra Heavy	48.3 x 5.4	25	33.7	2.6
50	Extra Light	60.3 x 2.3	40	48.3	6.4
50	Light	60.3 x 2.9	40	48.3	5.2
50	Medium	60.3 x 3.6	40	48.3	3.8
50	Heavy	60.3 x 4.5	40	48.3	2.0
50	Extra Heavy	60.3 x 5.4	40	48.3	0.2

Note: InfraBuild Steel Centre reserve the right to change specifications without notice. Not all products are available at all InfraBuild Steel Centre branches. InfraBuild Steel Centre also has access to a wide network of products not necessarily listed in this book. Please check with your local InfraBuild Steel Centre branch for product availability.

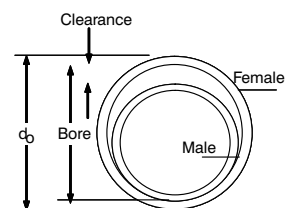

Note: Clearance =
 (AS/NZS 1163 Min do - 2t) -
 (AS/NZS 1163 Max do).

Note: CHS is not a precision tube and all dimensions shown in the chart, although in accordance with the specifications, may vary marginally within the tolerance bands permitted.

Sizes shown in bold print are sizes that provide a clearance of less than 2.0mm. The internal weld bead and variation in corner radii between sections will need to be considered when closer fits are indicated. Where telescoping over some length is desired, additional allowance may be needed for straightness. For tight fits it is suggested that some form of testing be carried out prior to committing material.

Telescoping CHS

Circular Hollow Sections (CONTINUED)

Female (Outer)			Male (Inner)		
DN	Quality	do t mm x mm	DN	di mm	Min. Clearance mm
65	Extra Light	76.1 x 2.3	50	60.3	9.8
65	Galtube® Plus	76.1 x 2.6	50	60.3	9.2
65	Light	276.1 x 3.2	50	60.3	8.0
65	Medium	76.1 x 3.6	50	60.3	7.2
65	Heavy	76.1 x 4.5	50	60.3	5.4
65	Extra Heavy	76.1 x 5.4	50	60.3	2.6
80	Extra Light	88.9 x 2.6	65	76.1	6.0
80	Light	88.9 x 3.2	65	76.1	4.8
80	Medium	88.9 x 4.0	65	76.1	3.2
80	Heavy	88.9 x 5.0	65	76.1	1.2
80	Extra Heavy	88.9 x 5.9	50	60.3	15.3
90	Extra Light	101.6 x 2.6	80	88.9	5.6
90	Light	101.6 x 3.2	80	88.9	4.4
90	Medium	101.6 x 4.0	80	88.9	2.8
90	Heavy	101.6 x 5.0	80	88.9	0.8
100	Extra Light	114.3 x 3.2	90	101.6	4.1
100	Light	114.3 x 3.6	90	101.6	3.3
100	Medium	114.3 x 4.5	90	101.6	1.5
100	Heavy	114.3 x 5.4	80	88.9	12.6
125	Extra Light	139.7 x 3.0	100	114.3	16.9
125	Light	139.7 x 3.5	100	114.3	15.9
125	Medium	139.7 x 5.0	100	114.3	12.9
125	Heavy	139.7 x 5.4	100	114.3	12.1
150	Light	165.1 x 3.0	125	139.7	15.4
150	Medium	165.1 x 5.0	125	139.7	12.4
150	Heavy	165.1 x 5.4	125	139.7	11.6

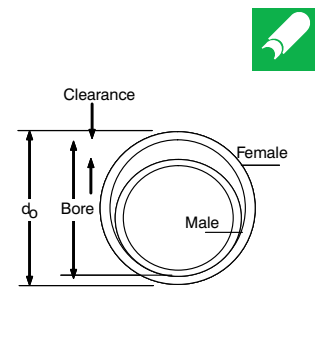

Note: Clearance =
 (AS/NZS 1163 Min di - 2t) -
 (AS/NZS 1163 Max do).

Note: CHS is not a precision tube and all dimensions shown in the chart, although in accordance with the specifications, may vary marginally within the tolerance bands permitted.

Sizes shown in bold print are sizes that provide a clearance of less than 2.0mm. The internal weld bead and variation in corner radii between sections will need to be considered when closer fits are indicated. Where telescoping over some length is desired, additional allowance may be needed for straightness. For tight fits it is suggested that some form of testing be carried out prior to committing material.

How to use this chart
 See page 41

End Colour Codes

Square and Rectangular sections (RHS)

Colour	Wall Thickness
	mm
Purple	1.6
Chocolate Brown	1.8
Yellow	2.0
Silver	2.3
Pink	2.5
Gold	2.8
Dark Blue	3.0
Grey	3.5
Green	4.0
Orange	5.0
White	6.0
Pink	7.0
Red	8.0
Purple	9.0



Note: Meets AS/NZS 4496:1997 (Recommended practice for the colour coding of steel products).



End Colour Codes

Circular Sections (CHS)

Colour	Gauge
Green end	Extra light (XL)
Yellow end	Light (L)
Blue end	Medium (M)
Red end	Heavy (H)
Cream end	Extra heavy (XH)



Note: Meets AS/NZS 4496:1997 (Recommended practice for the colour coding of steel products).



Plate

Flat Plate

Grade 250

Thickness mm	Mass kg/m	Width mm	Length m	kg/lineal metre of plate width
5	39.25	2400	6.0	94.2
5	39.25	2400	9.0	94.2
5	39.25	3000	9.0	117
6	47.10	2400	6.0	11
6	47.10	2400	9.0	11
6	47.10	3000	9.0	141
6	47.10	3200	12.0	151
8	62.80	1800	6.0	113
8	62.80	2400	6.0	151
8	62.80	2400	9.0	151
8	62.80	3000	9.0	188
8	62.80	3200	12.0	201
10	78.50	1800	6.0	141
10	78.50	2400	6.0	188
10	78.50	2400	9.0	188
10	78.50	3000	9.0	236
10	78.50	3200	12.0	251
12	94.20	1800	6.0	170
12	94.20	2400	6.0	226
12	94.20	2400	9.0	226
12	94.20	3000	6.0	283
12	94.20	3000	9.0	283
12	94.20	3200	12.0	301
16	125.60	1800	6.0	226
16	125.60	2400	6.0	301
16	125.60	2400	9.0	301
16	125.60	3000	6.0	377
16	125.60	3000	9.0	377
16	125.60	3200	12.0	402
20	157.00	1800	6.0	283
20	157.00	2400	6.0	377
20	157.00	2400	9.0	377
20	157.00	3000	9.0	471
20	157.00	3200	12.0	502
25	196.25	1800	6.0	353
25	196.25	2400	6.0	471
25	196.25	2400	9.0	471
25	196.25	3000	9.0	589
25	196.25	3200	12.0	628
28	219.80	2400	6.0	528
28	219.80	2400	9.0	528
32	251.20	1800	6.0	452
32	251.20	2400	6.0	603
32	251.20	2400	9.0	603
32	251.20	3000	9.0	754
36	282.60	2400	6.0	678
36	282.60	2400	9.0	678
40	314.00	1800	6.0	565
40	314.00	2400	6.0	754
40	314.00	2400	9.0	754



Typical Uses:

- General fabrication
- Structural members
- High-rise buildings
- Bridges
- Storage tanks

Features:

- Meets AS/NZ 3678:2016. (Structural Steel, Hot Rolled Floor Plates & slabs).
- A medium strength structural steel plate product with nominal yield strength of 250 MPa

Flat Plate

Grade 250

Thickness mm	Mass kg/m	Width mm	Length m	kg/lineal metre of plate width
45	353	2400	6.0	848
45	353	2400	9.0	848
50	393	1800	6.0	707
50	393	2400	6.0	942
50	393	2400	9.0	942
55	432	2400	6.0	1036
55	432	2400	8.4	1036
60	471	1800	6.0	848
60	471	2400	6.0	1130
70	550	1800	6.0	989
70	550	2400	6.0	1319
80	628	1800	6.0	1130
80	628	2400	5.2	1507
90	707	1800	6.0	1696
100	785	1800	5.6	1413
100	785	2400	4.0	1884
110	864	1800	5.0	1554
110	864	2400	3.7	2072
120	942	1800	4.6	1696
120	942	2400	3.4	2261
130	1021	1800	4.2	1838
130	1021	2400	3.1	2450
140	1099	1800	3.85	1978
140	1099	2400	2.9	2638
150	1178	1800	3.6	2120
150	1178	2400	2.7	2826



Typical Uses:

- General fabrication
- Structural members
- High-rise buildings
- Bridges
- Storage tanks

Features:

- Meets AS/NZ 3678:2016. (Structural Steel, Hot Rolled Floor Plates & slabs).
- A medium strength structural steel plate product with nominal yield strength of 250 MPa



XLERPLATE® Steel Plate

XLERPLATE® steel's consistent quality makes your manufacturing processes more efficient, helping you maintain your quality assurance and enhances your reputation as a supplier of high-calibre products.

Call your local branch to discuss your requirements

Flat Plate

Grade 350

Thickness mm	Mass kg/m	Width mm	Length m	kg/lineal metre of plate width
5	39.3	2400	6.0	94.2
5	39.3	2400	9.0	94.2
5	39.3	3000	9.0	118
6	47.1	2400	9.6	113
8	62.8	2400	9.6	151
10	78.5	2400	9.6	188
10	78.5	3100	9.6	243
12	94.2	2400	9.6	226
12	94.2	3100	9.6	292
16	126	2400	9.6	301
16	126	3100	9.6	389
20	157	2400	9.6	377
20	157	3100	9.6	487
25	196	2400	9.6	471
32	251	2400	9.6	603
40	314	2400	7.6	754
50	393	2400	7.6	942
60	471	2400	7.6	1130
70	550	2400	6.0	1319
80	628	2400	5.5	1507
90	707	2400	6.3	1696
90	707	2400	3.15	1696
100	785	2100	6.5	1649
100	785	2100	3.25	1649



Typical Uses:

- General fabrication
- Structural members
- High-rise buildings
- Bridges
- Storage tanks

Features:

- Meets AS/NZ 3678: 2016 (Structural Steel, Hot Rolled Floor Plates & slabs).
- A medium strength structural steel plate product with nominal yield strength of 350 MPa

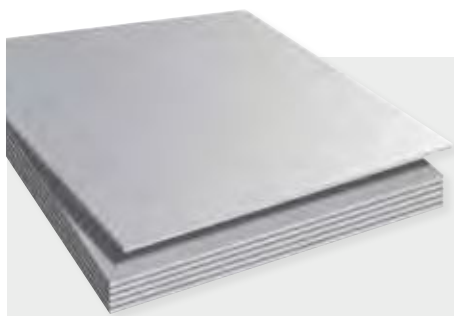

Plate Processing

InfraBuild Steel Centre can offer various plate processing options including Oxy profiling and bevelling, Plasma cutting, Flame cutting and cropping. We can also cut shapes, letters and numbers.

Applications include: Stripping, bevel cutting, stitch cutting, notching, punching, shearing & cropping.

Call your local branch to discuss your requirements

Plate

K1042 Plate

Thickness mm	Mass kg/m	Width mm	Length m	kg/lineal metre of plate width
12	94.20	2400	6.0	226
16	125.60	2400	6.2	301
20	157.00	2400	6.0	377
25	196.25	2400	6.0	471
32	251.20	2400	6.3	603
40	314.00	2400	7.6	754
50	392.50	2400	6.0	942
60	471.00	2400	6.0	1130
70	549.50	2400	5.8	1319
80	628.00	2400	5.0	1507



Typical Uses:

- General engineering parts
- Profile cut gears
- Wear/abrasion applications

Features:

- Meets AS/NZS 3678: 2016 - K1042
- A heat treatable plate grade for general engineering applications

Pressure Vessel Plate

Thickness mm	Mass kg/m	Width mm	Length m	kg/lineal metre of plate width
AS1548-PT430T				
5	39.25	2400	9.0	94.2
AS1548-PT460T				
6	47.10	3100	9.6	146
AS1548-PT460NR				
8	62.80	3100	9.6	195
10	78.50	3100	9.6	243
12	94.20	3100	9.6	292
16	125.60	3100	9.6	389
20	157.00	3100	8.6	4867
25	196.25	3100	9.6	608
32	251.20	2400	9.6	603
40	314.00	2400	9.6	754
50	392.50	2400	7.6	942
60	471.00	2400	6.0	1130
70	549.50	2400	6.0	1319
80	628.00	2400	5.2	1507
90	706.50	2400	5.2	1696
100	785.00	2400	5.2	1884



Typical Uses:

- Boiler
- Pressure Vessel

Features:

- Meets AS 1548:2008 (Fine grained, weldable steel plates for pressure equipment)
- A fully killed, fine grained, carbon-manganese steel with a guaranteed minimum tensile strength

Floor Plate

XLERPLATE® Grade 250 Steel

Thickness mm	Mass kg/m ²	Width mm	Length m	Pack Mass tonnes	Non-Stock lengths	
					mm	kg/LM
6	48.60	1800	6.0	1.9	6	87.5
8	64.80	1800	6.0	1.4	8	117
10	80.50	1800	6.0	1.2	10	145
12	96.20	1800	6.0	1.0	12	173



Features:

- Meets AS/NZS 1594: 2002
Meets AS/NZS 1365: 1996 - HA250
(Flat rolled steel products)
- Hot rolled structural product with minimum yield strength of 250MPa; good ductility and good weldability

Coil Plate

TRU-SPEC™ HA250

Thickness mm	Mass kg/m ²	Width mm	Length m	Pack Mass tonnes	Non-Stock lengths	
					mm	kg/LM
3	23.550	1200	2400	2	3	28.3
3	23.550	1200	6000	2	3	28.3
3	23.550	1500	3000	2	3	35.3
3	23.550	1500	6000	2	3	35.3
4	31.400	1200	2400	2	4	37.7
4	31.400	1500	3000	2	4	47.1
4	31.400	1500	6000	2	4	47.1
5	39.250	1200	2400	2	5	47.1
5	39.250	1500	3000	2	5	58.9
5	39.250	1500	6000	2	5	58.9
6	47.100	1200	2400	2	6	56.5
6	47.100	1500	3000	2	6	70.7
6	47.100	1500	6000	2	6	70.7
8	62.800	1200	2400	2	8	75.4
8	62.800	1500	3000	2	8	94.2
10	78.500	1200	2400	2	10	94.2
10	78.500	1500	3000	2	10	118
12	94.200	1200	2400	2	12	113
12	94.200	1500	3000	2	12	141



Typical Uses:

- Brake press forming applications
- General fabrication
- Laser cutting

Features:

- Meets AS/NZS 1594: 2002
Meets AS/NZS 1365: 1996
- Hot rolled structural product with minimum yield strength of 250MPa; good ductility and good weldability

Floor Plate

TRU-SPEC™ HA250

Thickness mm	Mass kg/m ²	Width mm	Length m	Pack Mass tonnes	Non-Stock lengths	
					mm	kg/LM
3	25.550	1200	2400	2	3	30.7
3	25.550	1200	6000	2	3	30.7
5	41.250	1200	2400	2	5	49.5
5	41.250	1200	6000	2	5	49.5
5	41.250	1500	6000	2	5	61.9
6	49.100	1200	6000	2	6	58.9
6	49.100	1500	6000	2	6	73.7
8	64.800	1500	6000	2	8	97.2



Typical Uses:

- Floorplate

Features:

- Meets AS/NZS 1594: 2002
Meets AS/NZS 1365: 1996 - HA250 (Flat rolled steel products)
- Hot rolled structural product with minimum yield strength of 250MPa; good ductility and good weldability

Coil Plate

TRU-SPEC™ HA350

Thickness mm	Mass kg/m ²	Width mm	Length m	Pack Mass tonnes	Non-Stock lengths	
					mm	kg/LM
5	39.250	1500	8000	2	5	58.9
6	47.100	1200	6000	2	6	56.5
6	47.100	1500	6000	2	6	70.6
8	62.800	1200	6000	2	8	75.4



Features:

- Meets AS/NZS 1594: 2002
Meets AS/NZS 1365: 1996
- Hot rolled structural product with minimum yield strength of 350MPa; good ductility and good weldability

Wear Plate

BISALLOY®



Bisalloy
WEAR

Typical Uses:

- Demolition tools
- Ground engaging tools
- Earthmoving buckets
- Drag Line buckets
- Wear plates
- Chutes

Thickness mm	Mass kg/m ²	BISALLOY® Wear 320 steel	BISALLOY® Wear 400 steel	BISALLOY® Wear 450 steel
		Tensile strength: Typical - 1070 MPA	Tensile strength: Typical - 1320 MPA	Tensile strength: Typical - 1400 MPA
5	39.3	1525 x 8000	1526 x 8000	
6	47.1	1525 x 8000	1526 x 8000	2485 x 8000
6	47.1	2485 x 8000	2485 x 8000	2485 x 8000
8	62.8	2485 x 8000	2486 x 8000	2485 x 8000
10	78.5	2485 x 8000	2485 x 8000	2485 x 8000
10	78.5	3100 x 8000	3100 x 8000	3100 x 8000
12	94.2	2485 x 8000	2485 x 8000	2485 x 8000
12	94.2	3100 x 8000	3100 x 8000	3100 x 8000
16	125	2485 x 8000	2485 x 8000	2485 x 8000
16	125	3100 x 8000	3100 x 8000	3100 x 8000
20	157	2485 x 8000	2485 x 8000	2485 x 8000
20	157	3100 x 8000	3100 x 8000	3100 x 8000
25	196	2485 x 8000	2485 x 8000	2485 x 8000
25	196	3100 x 8000	3100 x 8000	3100 x 8800
32	251	2485 x 8000	2485 x 8000	2485 x 8500
40	314	2485 x 8000	2485 x 8000	2485 x 8000
50	393	2485 x 8000	2485 x 8000	2485 x 8000
60	471	2485 x 6000	2485 x 6000	2485 x 6000
70	549	1900 x 6000	1900 x 6000	1900 x 6000
75	589	1900 x 6000	1900 x 6000	1900 x 6000
80	628	1900 x 6000	1900 x 6000	1900 x 6000
90	706	1600 x 6000	1600 x 6000	1900 x 6000
100	785	1525 x 6000	1525 x 6000	1525 x 6000

Thickness mm	Mass kg/m ²	BISALLOY® Wear 500 steel	BISALLOY® Wear 600 steel
		Tensile strength: Typical - 1640 MPA	Tensile strength: Typical - 2050 MPA
8	62.8	2485 x 8000	
10	78.5	2485 x 8000	
10	78.5	2485 x 8000	
12	94.2	2485 x 8000	2485 x 8000
12	94.2	2485 x 8000	2485 x 8000
16	126	2485 x 8000	2485 x 8000
16	126	2485 x 8000	2485 x 8000
20	157	2485 x 8000	2485 x 8000
20	157	2485 x 8000	2485 x 8000
25	196	2485 x 8000	2485 x 8000
25	196	2485 x 8000	2485 x 8000
32	251	2485 x 8000	2485 x 8000
40	314	2485 x 8000	2485 x 8000
50	393	2485 x 8000	2485 x 6000
60	471	2485 x 6000	
70	549	1900 x 6000	
75	589	1900 x 6000	
80	628	1900 x 6000	
90	706	1525 x 6000	
100	785	1525 x 6000	

Note: InfraBuild Steel Centre reserve the right to change specifications without notice. Not all products are available at all InfraBuild Steel Centre branches. InfraBuild Steel Centre also has access to a wide network of products not necessarily listed in this book. Please check with your local InfraBuild Steel Centre branch for product availability.

Structural Plate

BISALLOY®



Thickness mm	Mass kg/m ²	BISALLOY® Structural 60 steel	BISALLOY® Structural 70 steel	BISALLOY® Structural 80 steel	BISALLOY® Structural 100 steel
		Tensile strength: Typical - 640 MPA	Tensile strength: Typical - 760 MPA	Tensile strength: Typical - 830 MPA	Tensile strength: Typical - 1000 MPA
5	39.3	1525 x 8000	1525 x 8000	1525 x 8000	1525 x 8000
6	47.1	1525 x 8000	1525 x 8000	1525 x 8000	1525 x 8000
6	47.1	2485 x 8000	2485 x 8000	2485 x 8000	2485 x 8000
8	62.8	2485 x 8000	2485 x 8000	2485 x 8000	2485 x 8000
10	78.5	2485 x 8000	2485 x 8000	2485 x 8000	2485 x 8000
10	78.5	3100 x 8000	3100 x 8000	3100 x 8000	3100 x 8000
12	94.2	2485 x 8000	2485 x 8000	2485 x 8000	2485 x 8000
12	94.2	3100 x 8000	3100 x 8000	3100 x 8000	3100 x 8000
16	126	2485 x 8000	2485 x 8000	2485 x 8000	2485 x 8000
16	126	3100 x 8000	3100 x 8000	3100 x 8000	3100 x 8000
20	157	2485 x 8000	2485 x 8000	2485 x 8000	2485 x 8000
20	157	3100 x 8000	3100 x 8000	3100 x 8000	3100 x 8000
25	196	2485 x 8000	2485 x 8000	2485 x 8000	2485 x 8000
25	196	3100 x 8000	3100 x 8000	3100 x 8000	3100 x 8000
32	251	2485 x 8000	2485 x 8000	2485 x 8000	2485 x 8000
40	314	2485 x 8000	2485 x 8000	2485 x 8000	2485 x 8000
50	393	2485 x 8000	2485 x 8000	2485 x 8000	2485 x 8000
60	471	2485 x 6000	2485 x 6000	2485 x 6000	2485 x 6000
70	549	1900 x 6000	1900 x 6000	1900 x 6000	1900 x 6000
75	589	1900 x 6000	1900 x 6000	1900 x 6000	1900 x 6000
80	628	1900 x 6000	1900 x 6000	1900 x 6000	1900 x 6000
90	706	1600 x 6000	1600 x 6000	1600 x 6000	1600 x 6000
100	785	1525 x 6000	1525 x 6000	1525 x 6000	1525 x 6000



Typical Uses:

- Transport Equipment such as Low Loaders
- Structural Components for Mining Dump Trucks and other Mobile Equipment
- Mining Equipment Roll Over Protection Systems (ROPS)
- Underground Longwall Mining Supports
- Storage Tanks for water, oil and gas
- Columns for Low and High Rise Buildings
- Transfer Beams for Low and High Rise Buildings
- Road and Rail Bridge Beams and Columns
- Excavator Buckets
- Mobile Lifting Equipment
- Overhead Cranes
- Container Handling Equipment

Note: InfraBuild Steel Centre reserve the right to change specifications without notice. Not all products are available at all InfraBuild Steel Centre branches. InfraBuild Steel Centre also has access to a wide network of products not necessarily listed in this book. Please check with your local InfraBuild Steel Centre branch for product availability.

Sheet and Coil Thickness Terminology

B.M.T. vs. T.C.T. vs. T.P.T.

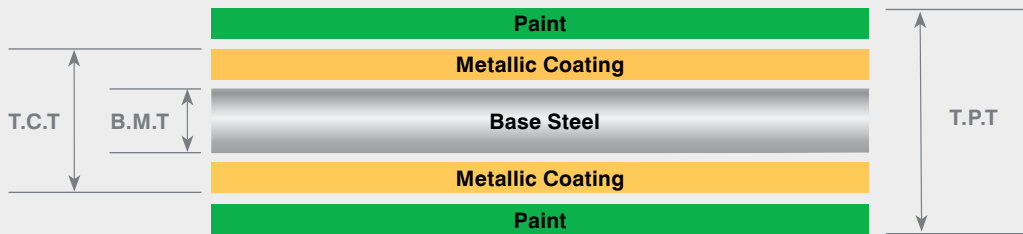

When ordering through different suppliers or importing sheet & coil products, it is important to understand the difference between B.M.T., T.C.T. & T.P.T.

B.M.T. = Base Metal Thickness. This excludes any coatings applied to the base metal sheet.

T.C.T. = Total Coated Thickness. This measures both the base sheet and the coating. For example: Zinalume, Galvanised, Zincanneal and Electro-Galv.

T.P.T. = Total Painted Thickness. This applies to painted sheets such as Colorbond and Signwhite.

This is only a factor in coated material and painted material. Manufactured painted products (ie. Colorbond) use a metallic-coated base metal.

Most suppliers quote base metal thickness, B.M.T. but it is important the user understands how different coatings will change the thickness.

BRIGHTFORM® Sheet

Base Metal Thickness mm	Width mm	kg/m ²
1.60	910	12.6
1.60	1210	12.6
1.60	1510	12.6
2.00	910	15.7
2.00	1210	15.7
2.00	1510	15.7
2.50	1210	19.6
2.95	1210	23.2
3.00	910	23.6
3.00	1210	23.6



Typical Uses:

- Tubing
- Shelving
- Simple pressings
- Hidden appliance panels

Features:

- Meets AS/NZS 1365: 1996 (Tolerances for flat rolled steel products)
- Pickled, skin-passed low carbon steel with a good surface, suitable for bending and moderate drawing and pressing.

Hot Rolled Sheet

Formable HA1S Steel

Base Metal Thickness mm	Width mm	kg/m ²
1.50	1200	11.8
1.50	1210	11.8
1.60	910	12.6
1.60	1195	12.6
1.60	1200	12.6
1.60	1210	12.6
1.95	900	15.3
1.95	1195	15.3
1.95	1200	15.3
1.95	1210	15.3
2.40	1200	18.8
2.50	1195	19.6
2.50	1210	19.6
2.50	1495	19.6
2.50	1510	19.6
2.90	1210	22.8
2.90	1500	22.8
2.95	1200	23.2
2.95	1500	23.2
2.95	1800	23.2
3.00	895	23.6
3.00	1195	23.6
3.00	1210	23.6
3.00	1495	23.6
3.00	1510	23.6
3.00	1800	23.6



Typical Uses:

- Shelving
- Light structural members
- Tanks

Features:

- Meets AS/NZS 1594: 2002 (Flat rolled steel products) and AS/NZS 1365: 1996 (Tolerances for flat rolled steel products)
- Skin-passed, Hot-rolled low carbon steel suitable for simple forming, bending and welding operations.

Hot Rolled, Pickled and Oiled Sheet

HA3 Steel

Base Metal Thickness mm	Width mm	kg/m ²
1.60	1210	12.6
2.00	910	15.7
2.00	1210	15.7
2.50	1210	19.6
3.00	1210	23.6
4.00	1210	31.4
5.00	1210	39.3
6.00	1210	47.1



Typical Uses:

- Agricultural machinery
- Automotive components
- Sealed unit housings
- Mower parts
- Brackets
- Furniture

Features:

- Meets joint AS/NZS 1594: 2002 (Flat rolled steel products) and AS/NZS 1365: 1996 (Tolerances for flat rolled steel products)
- Hot rolled, formable steel suitable when pickled for medium drawing and heavy pressing operations.

Cold Rolled Sheet

CA3SN-G

Base Metal Thickness mm	Width mm	kg/m ²
0.60	1220	4.71
0.80	1220	6.28
1.00	1220	7.85
1.20	1220	9.42
1.50	1220	11.8
1.60	1220	12.6
2.00	1220	15.7
2.50	1220	19.6
3.00	1220	23.6



Typical Uses:

- Unexposed drawn parts for automotive and appliance end uses.

Features:

- Meets AS/NZS 1595: 1998 (Cold-rolled, unalloyed, steel sheet and strip)
- Cold rolled, skin-passed deep drawing steel guaranteed non-ageing and free from stretcher stain with a general purpose surface.



TRU-SPEC® Steel Plate

TRU-SPEC® steel is available in a range of structural grades, widths and lengths. Typically used in light and standard structural members, brake press forming applications, light poles, trailer and automotive components, general fabrications and galvanising applications.

The benefits of selecting TRU-SPEC® steel include:

- Guaranteed minimum strength levels
- Various levels of weldability, formability and ductility (Good and Excellent)
- Excellent for galvanising applications
- Enhanced weather resistance

BlueScope's stretch levelling process provides a consistently flat and 'memory-free' product every time particularly suited to the industry's growing preference towards laser cutting.

TruSpec®



Call your local branch to discuss your requirements

GALVABOND® Sheet

G2 Z275

Base Metal Thickness mm	Width mm	kg/m ²
0.40	915	3.43
0.40	1220	3.43
0.45	915	3.82
0.50	1220	4.22
0.55	915	4.61
0.55	1200	4.61
0.55	1220	4.61
0.55	1500	4.61
0.60	1525	5.00
0.70	1220	5.79
0.75	915	6.18
0.75	1200	6.18
0.75	1220	6.18
0.75	1500	6.18
0.80	1525	6.57
0.90	915	7.36
0.90	1220	7.36
0.95	1200	7.75
0.95	1220	7.75
0.95	1500	7.75
1.00	1220	8.14
1.00	1525	8.14
1.10	915	8.92
1.10	1220	8.92
1.15	915	9.32
1.15	1200	9.32
1.15	1220	9.32
1.15	1500	9.32
1.20	1525	9.71
1.50	915	12.1
1.50	1220	12.1
1.50	1500	12.1
1.55	1200	12.5
1.55	1220	12.5
1.55	1500	12.5
1.60	1525	12.9
1.90	1220	15.2
1.95	1200	15.6
1.95	1220	15.6
2.40	1220	19.1
2.45	1200	19.5
2.90	1220	23.1



Typical Uses:

- Tube
- Air conditioning ducts,
- Air conditioning panels,
- Meter boxes
- Trailers
- Partitioning systems
- Cable trays
- Scaffolding planks
- Rendering mesh
- Feeder troughs

Features:

- Meets AS/NZS 1365: 1996 (Tolerances for flat rolled steel products) and AS 1397: 2011 (Continuous hot-dip metallic coated steel sheet and strip - Coatings of zinc and zinc alloyed with aluminium and magnesium)
- Galvabond G2 steel is a hot-dipped zinc-coated commercial forming steel with a spangled surface, suitable for general manufacturing. Product is suitable for moderate drawing applications and is suitable for lockseaming up to 1.6mm thick.

ZINCANNEAL® Sheet

G2S ZF100

Base Metal Thickness mm	Width mm	kg/m ²
0.50	1220	4.06
0.55	1220	4.45
0.70	1220	5.63
0.75	1220	6.02
0.80	1200	6.41
0.90	915	7.19
0.90	1220	7.19
0.95	1200	7.59
0.95	1220	7.59
1.00	1200	7.98
1.10	1200	8.77
1.10	1220	8.77
1.15	1200	9.16
1.15	1220	9.16
1.20	1200	9.55
1.40	1220	11.1
1.50	915	11.9
1.50	1200	11.9
1.50	1220	11.9
1.55	1200	12.3
1.60	1200	12.7
1.90	1220	15.1
1.95	1200	15.4



Note: hot-dipped zinc/iron alloy-coated commercial forming steel with a skin-passed smooth surface suitable for direct-on painting. Some powdering of the coating may occur with severe deformation.

Typical Uses:

- Exposed painted panels
- Non-exposed automotive panels
- Washing machines
- Acoustic ceiling tiles
- Door frames
- Switchboards
- Commercial fridges & freezers

Features:

- Meets AS/NZS 1365: 1996 (Tolerances for flat rolled steel products) and AS 1397: 2011 (Continuous hot-dip metallic coated steel sheet and strip - Coatings of zinc and zinc alloyed with aluminium and magnesium)
- Zinccanneal G2S is a matte manufacturing. Product is suitable for moderate drawing applications and is suitable for lockseaming up to 1.6mm thick.

ZINCALUME® Sheet

G300 AZ150

Base Metal Thickness mm	Width mm	kg/m ²
0.40	1200	3.31
0.55	1200	4.49
0.55	900	4.49
0.75	1200	6.06
1.00	900	8.02
1.00	1200	8.02
1.20	900	9.59
1.20	1200	9.59



Typical Uses:

- Rainwater goods
- Gutters
- Garden sheds

Features:

- Meets AS/NZS 1365: 1996 (Tolerances for flat rolled steel products) and AS 1397: 2011 (Continuous hot-dip metallic coated steel sheet and strip - Coatings of zinc and zinc alloyed with aluminium and magnesium)
- Zincalume G300 steel is a hot-dipped zinc/aluminium alloy-coated structural steel with a regular spangle surface and a guaranteed minimum yield strength of 300MPa with good ductility. Suitable for roll forming to a minimum internal diameter of 1t.

Zincalume®

COLORBOND® Sheet

Grade 300

Size mm x mm x mm	Colours	Mass sheets/tonne
1200 x 2400 x 0.55		76
1200 x 3050 x 0.55	Manor Red® Jasper® Classic Cream™ Surfmist®	60
1200 x 3660 x 0.55	Paperbark® Dune® Shale Grey™ Windspray® Woodland Grey® Pale Eucalypt® Wilderness®	51
1200 x 2400 x 0.80	Cottage Green® Monument™ Deep Ocean® Ironstone® Evening Haze®	63
1200 x 3000 x 0.80		43
1200 x 2440 x 0.55	Appliance	76
1200 x 1800 x 0.55	Sign White	100



Colorbond®

Note: All colours listed are trademarks or registered trademarks of BlueScope Steel Ltd.

Typical Uses:

- Roofing & accessories
- Wall cladding
- Rainwater goods.

Features:

- Colorbond prepainted steel is specifically designed by BlueScope Steel to provide a high durability, premier cladding and roofing material for general use.

COLORBOND® Steel Standard Colour Range



The printed steel colours shown here have been reproduced to represent actual colours as accurately as possible. However we recommend checking your chosen colour against an actual product sample before purchasing as varying light conditions and print limitations affect colour tones.

Note: InfraBuild Steel Centre reserve the right to change specifications without notice. Not all products are available at all InfraBuild Steel Centre branches. InfraBuild Steel Centre also has access to a wide network of products not necessarily listed in this book. Please check with your local InfraBuild Steel Centre branch for product availability.

Reinforcing Bar and Mesh

HANDIMESH®

Galvanized

Product Code	Std Unit	Longitudinal Wires*	Cross Wires*	Mass (kg)	Dimensions (m)
G112A	Sheet	97 x 2.5 @ 25	121 x 2.5 @ 25	22	3 x 2.4
G122A	Sheet	97 x 2.5 @ 25	61 x 2.5 @ 50	17	3 x 2.4
G113	Sheet	97 x 3.2 @ 25	121 x 3.2 @ 25	36	3 x 2.4
G123	Sheet	97 x 3.2 @ 25	61 x 3.2 @ 50	27	3 x 2.4
G234	Sheet	49 x 4 @ 50	41 x 4 @ 75	24	3 x 2.4
G235	Sheet	49 x 5 @ 50	41 x 5 @ 75	38	3 x 2.4
G224	Sheet	49 x 4 @ 50	61 x 4 @ 50	29	3 x 2.4
G225	Sheet	49 x 5 @ 50	61 x 5 @ 50	45	3 x 2.4
G445	Sheet	25 x 5 @ 100	31 x 5 @ 100	23	3 x 2.4
G445A	Sheet	25 x 5.6 @ 100	31 x 5.6 @ 100	29	3 x 2.4
G465A	Sheet	25 x 5.6 @ 100	21 x 5.6 @ 150	24	3 x 2.4

* Number of Wires x Diameter (mm) @ Spacing (mm)

Typical Uses:

- General Purpose Applications
- DIY & Home Improvement

Features:

- Also available in 'bright wire' on request.



UTEMESH®

Ribbed Square Mesh

Product Code	Std Unit	Longitudinal Wires*	Cross Wires*	Mass (kg)	Dimensions (m)
SL62UTE	Sheet	8 x 6 @ 200 +4 x 4.24 @ 100	20 x 6 @ 200	18	4 x 2
SL72UTE	Sheet	8 x 6.75 @ 200 +4 x 4.75 @ 100	20 x 6.75 @ 200	23	4 x 2
SL82UTE	Sheet	8 x 7.6 @ 200 +4 x 5.35 @ 100	20 x 7.6 @ 200	30	4 x 2

* Number of Wires x Diameter (mm) @ Spacing (mm)

Typical Uses:

- Residential Construction
- Driveways and paths
- Shed slabs
- Smaller concreting jobs

Features:

- AS/NZS 4671 - Steel for the reinforcement of concrete
- Versatile and lightweight
- Minimises wastage
- Can be handled by one person (using the correct handling techniques)
- Safe and legal to transport
- Easy to setup, place and tie



Note: *AS/NZS 4671 – Steel for the reinforcement of concrete UTEMESH® has been designed to conform to road traffic authorities' regulations for transportation of oversize products. UTEMESH® can also be handled by one person using the appropriate lifting techniques. Now safer to handle with reduced flying ends (reduced to 20 mm). Up to 8% improved mesh cover through lap efficiency across and along the sheet.

ONEMESH®

Ribbed Rectangular Mesh

Product Code	Std Unit	Longitudinal Wires*	Cross Wires*	Mass (kg)	Dimensions (m)
RL718	Sheet	25 x 6.75 @ 100	30 x 7.6 @ 200	67	6 x 2.4
RL818	Sheet	25 x 7.6 @ 100	30 x 7.6 @ 200	79	6 x 2.4
RL918	Sheet	25 x 8.6 @ 100	30 x 7.6 @ 200	93	6 x 2.4
RL1018	Sheet	25 x 9.5 @ 100	30 x 7.6 @ 200	109	6 x 2.4
RL1118	Sheet	25 x 10.7 @ 100	30 x 7.6 @ 200	130	6 x 2.4
RL1218	Sheet	25 x 11.9 @ 100	30 x 7.6 @ 200	157	6 x 2.4

* Number of Wires x Diameter (mm) @ Spacing (mm)

Features: AS/NZS 4671 - Steel for the reinforcement of concrete

Note: InfraBuild Steel Centre reserve the right to change specifications without notice. Not all products are available at all InfraBuild Steel Centre branches. InfraBuild Steel Centre also has access to a wide network of products not necessarily listed in this book. Please check with your local InfraBuild Steel Centre branch for product availability.



ONEMESH®

Ribbed Square Mesh

Product Code	Std Unit	Longitudinal Wires*	Cross Wires*	Mass (kg)	Dimensions (m)
SL62	Sheet	10 x 6 @ 200 +4 x 4.24 @ 100	30 x 6 @ 200	33	6 x 2.4
SL72	Sheet	10 x 6.75 @ 200 +4 x 4.75 @ 100	30 x 6.75 @ 200	41	6 x 2.4
SL81	Sheet	25 x 7.6 @ 100	60 x 7.6 @ 100	105	6 x 2.4
SL82	Sheet	10 x 7.6 @ 200 +4 x 5.35 @ 100	30 x 7.6 @ 200	52	6 x 2.4
SL92	Sheet	10 x 8.6 @ 200 +4 x 6 @ 100	30 x 8.6 @ 200	66	6 x 2.4
SL102	Sheet	10 x 9.5 @ 200 +4 x 6.75 @ 100	30 x 9.5 @ 200	80	6 x 2.4
SL53 (WA ONLY)	Sheet	6 x 4.75 @ 300 +4 x 4.75 @ 100	20 x 4.75 @ 300	14	6 x 2.3
SL63 (WA ONLY)	Sheet	6 x 6 @ 300 +4 x 4.75 @ 100	20 x 6 @ 300	21	6 x 2.3

* Number of Wires x Diameter (mm) @ Spacing (mm)

Features: AS/NZS 4671 - Steel for the reinforcement of concrete

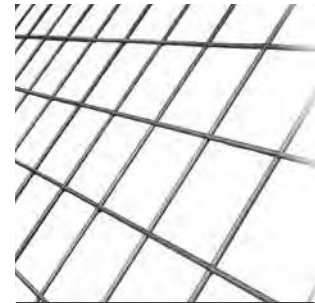

Plain Square Mesh

Product Code	Std Unit	Longitudinal Wires*	Cross Wires*	Mass (kg)	Dimensions (m)
F411	Roll	25 x 4 @ 100	601 x 4 @ 100	290	60 x 2.4
F41ST	Roll	23 x 4 @ 100	601 x 4 @ 100	275	60 x 2.4
F41	Sheet	25 x 4 @ 100	61 x 4 @ 100	29	6 x 2.4

* Number of Wires x Diameter (mm) @ Spacing (mm)

Features: Multi-purpose square mesh

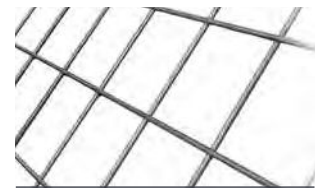

Trench Mesh

Product Code	Std Unit	Longitudinal Wires*	Mass (kg)	Dimensions (m)
L8TM200	Sheet	3 x 7.6 @ 100	6.8	6 x 0.2
L8TM300	Sheet	4 x 7.6 @ 100	9.2	6 x 0.3
L8TM400	Sheet	5 x 7.6 @ 100	11.6	6 x 0.4
L8TM500	Sheet	6 x 7.6 @ 100	13.9	6 x 0.5
L11TM200	Sheet	3 x 10.7 @ 100	13.3	6 x 0.2
L11TM300	Sheet	4 x 10.7 @ 100	17.7	6 x 0.3
L11TM400	Sheet	5 x 10.7 @ 100	22.3	6 x 0.4
L11TM500	Sheet	6 x 10.7 @ 100	26.8	6 x 0.5
L12TM200	Sheet	3 x 11.9 @ 100	15.8	6 x 0.2
L12TM300	Sheet	4 x 11.9 @ 100	21.2	6 x 0.3
L12TM400	Sheet	5 x 11.9 @ 100	26.5	6 x 0.4
L12TM500	Sheet	6 x 11.9 @ 100	31.9	6 x 0.5
FTM16200	Sheet	3 x 16 @ 100	30.6	6 x 0.2
FTM16300	Sheet	4 x 16 @ 100	41.1	6 x 0.3

* Number of Wires x Diameter (mm) @ Spacing (mm)

Features: AS/NZS 4671 - Steel for the reinforcement of concrete



Deformed Reinforcing Bar

Class N

Product Code	Mass kg/m	Length (m/t)
N10S	0.64	1552
N12S	0.93	1077
N16S	1.65	605
N20S	2.58	387
N24S	3.71	269
N28S	5.05	198
N32S	6.59	151
N36S	8.35	119
N40S	10.3	97



Note: Calculated mass includes an allowance for rolling manufacturing variations as per our Terms and Conditions. N40S is available only on request – Lead time required. AS/NZS 4671 - Steel for the reinforcement of concrete.

Reinforcing Accessories

Danley Tape			
Product Code	Type	Width (mm)	Length (m)
STEGOST95	Seaming Tape	95	55
STEGOCT75	Claw Tape	75	55
STEGOTT51	Tack Tape	51	15



Plastic Mesh Chairs Clipfast		
Product Code	Height (mm)	No./Bag
PC20M	20	100
PC25M	25	
PC30M	30	
PC32M	32	
PC40M	40	
PC50M	50	
PC65M	65	
PC75M	75	



Note: InfraBuild Steel Centre reserve the right to change specifications without notice. Not all products are available at all InfraBuild Steel Centre branches. InfraBuild Steel Centre also has access to a wide network of products not necessarily listed in this book. Please check with your local InfraBuild Steel Centre branch for product availability.

Reinforcing Accessories

Plastic Bar Chairs		
Product Code	Height (mm)	No./Bag
COM2540	25 or 40	
COM5065	50 or 65	
COM5065C	50 or 65	
COM7590	75 or 90	
COM7590C	75 or 90	
COM85100	85 or 100	
COM105110	105 or 110	100
COM115120	115 or 120	
COM125130	125 or 130	
COM135140	135 or 140	
COM145150	145 or 150	
COM155160	155 or 160	
COM165170	165 or 170	

C = Clip on

Typical Uses:

- Slab on ground
- Polystyrene pod slab
- Swimming pools

Features:

- Sets concrete cover
- Dual heights
- Clip-on mechanism for stability
- Integrated base to minimise puncture of polythene film

Tie Wire Roll		
Product Code	Wire Diameter (mm)	Length (m) Approximate
TW	1.6	60
TW5	1.6	320
TW10	1.6	650
TW315	3.15	16

Tie Wire Belt Pack Black		
Product Code	Wire Diameter (mm)	Length (m) Approximate
BP1.4	1.4	100
BP1.5	1.5	93

Tie Wire Belt Pack Galvanised		
Product Code	Wire Diameter (mm)	Length (m) Approximate
BP1.5GAL	1.5	93

Note: Large range of reinforcing accessories available - contact your local **InfraBuild** Steel Centre branch for assistance.

Note: InfraBuild Steel Centre reserve the right to change specifications without notice. Not all products are available at all InfraBuild Steel Centre branches. InfraBuild Steel Centre also has access to a wide network of products not necessarily listed in this book. Please check with your local InfraBuild Steel Centre branch for product availability.



Aluminium Circular Tube

Size mm x mm	Die	Length mm	Alloy / Temper	Weight Kg
12 x 1.6	EX5004	6500	6060 T5	0.917
16 x 1.6	EX5006	6500	6060 T5	1.268
19 x 1.2	E40149	6500	6060 T5	1.177
20 x 1.6	EX5008	6500	6060 T5	1.575
25 x 1.6	EX5010	6500	6060 T5	1.908
25 x 3.0	EX5011	6500	6060 T5	3.64
32 x 1.6	EX5013	6500	6060 T5	2.685
32 x 3.0	EX5014	6500	6060 T5	4.428
38.09 x 3.25	EX2078	6000	6060 T5	5.76
38.1 x 3.25	E40016	6500	6060 T5	6.247
40 x 3.0	EX5017	6500	6060 T591	6.123
44.45 x 3.25	EX2101	6000	6060 T591	6.816
46 x 3.5	E40700	6000	6060 T591	7.572
48.41 x 4.47	EX2202	6000	6005A T5	9.996
50 x 1.6	EX5018	6500	6060 T5	4.271
50 x 2.0	EX5019	6500	6060 T591	5.291
50 x 3.0	EX5041	6500	6082 T5	7.176
50 x 4.0	EX5081	6500	6082 T5	9.366
50 x 6.0	E40545	6500	6060 T5	13.428
60 x 2.0	EX5021	6500	6063 T6	1.968
60 x 3.0	EX5022	6500	6060 T591	9.425
60 x 5.0	EX5071	6500	6060 T591	15.165
63.5 x 3.95	E40098	6000	6060 T4	6.384
76.19 x 4.75	EX2207	6500	6060 T1	17.256
76.19 x 6.35	EX2153	6500	6005 T5	24.453
76.2 x 3.2	EP13843	6500	6060 T4	12.678
76.2 x 3.8	EP8552	6500	6060 T5	15.171
80 x 3.0	EX5024	6500	6060 T5	12.734
88.9 x 5.33	EX2161	6500	6060 T5	22.668
100 x 3.0	EX5026	6500	6060 T5	16.042



Note: * Sizes not available in all states

Aluminium Rectangular Tube

Size mm x mm	Die	Length mm	Alloy / Temper	Weight Kg
38 x 25 x 1.5 RAD	E22174	6500	6106 T6	3.06
40 x 20 x 2.0 RAD	E22169	6500	6060 T5	3.89
40 x 25 x 2.5	EB1014	6500	6060 T5	5.27
40 x 25 x 3.0 RAD	E22122	6500	6060 T5	6.09
50 x 25 x 1.6	EQ3359	6500	6060 T5	4.03
50 x 25 x 2.5	EU7751	6500	6060 T5	6.14
50 x 25 x 3.0	EL8012	6000	6082 T5	6.71
50 x 25 x 3.0 RAD	EW5373	6500	6060 T5	7.13
50 x 40 x 3.0	EL8013	6500	6082 T5	8.85
60 x 40 x 3.0	EL8015	6500	6060 T5	9.90
65 x 16 x 1.2 RAD	EQ6823	6500	6060 T5	3.22
65 x 16 x 1.4 RAD	EQ6948	6500	6060 T5	3.74
75 x 50 x 3.0	EL8017	6500	6060 T5	12.5
76.2 x 25.4 x 2.4	EL4238	6500	6060 T5	8.16
76.2 x 50.8 x 1.6	EQ1915	6000	6060 T5	6.42
80 x 25 x 3.0	EL8018	6500	6060 T5	10.4
80 x 40 x 3.0	EL8019	6500	6060 T5	12.0
80 x 50 x 3.0	EL8020	6500	6060 T5	13.1
100 x 25 x 2.5	EL8021	6500	6060 T5	10.5
100 x 25.2 x 1.60	EQ2698	6500	6060 T5	6.85
100 x 40 x 3.0	EL8023	6500	6060 T5	14.1
100 x 50 x 1.6	EL8024	6500	6060 T5	8.24
100 x 50 x 1.6	EP8087	6500	6106 T6	8.25
100 x 50 x 3.0	EL8025	6500	6063 T5	6.48
100 x 50 x 3.0 RAD	E22177	6000	6082 T5	14.0
100 x 50 x 6 RAD	EB1592	6000	6082 T5	10.7
101.6 x 76.2 x 2.29 RAD	EG5074	8000	6060 T5	16.8
125 x 40 x 3.0	EL8028	6500	6060 T5	16.7
125 x 50 x 3.0	EL8030	6500	6060 T5	17.8
150 x 50 x 3.0	EL8033	6500	6060 T5	20.4
150 x 50 x 3.0 RAD	E22178	6500	6063 T5	20.5
200 x 50 x 3.0	EL8035	6500	6060 T5	7.91
250 x 50 x 3	E22173	6500	6106 T6	21.4



Note: * Sizes not available in all states

Aluminium Square Tube

Size mm x mm	Die	Length mm	Alloy / Temper	Weight Kg
19.05 x 1.2	EK1333	6500	6060 T5	1.50
20 x 1.6	E22101	6500	6060 T5	2.07
20 x 3.0	EL2299	6500	6060 T5	3.58
20 x 3.0 RAD	E51872	6500	6060 T591	3.44
25 x 1.5 RAD	EL8819	6500	6060 T5	2.48
25 x 1.6	E22103	6500	6060 T5	2.63
25 x 2.0 RAD	EN3238	6500	6060 T5	3.23
25 x 3.0	EL8003	6500	6060 T5	4.64
25 x 3.0 RAD	E22120	6500	6060 T5	4.50
25 x 3.0 RAD	EQ4067	6500	6060 T591	4.64
32 x 3.0	EL8005	6500	6060 T5	6.11
40 x 1.6	EL7938	6500	6060 T5	4.32
40 x 2 RAD	EQ6818	6500	6060 T5	5.21
40 x 2.0	EQ4000	6500	6060 T5	5.34
40 x 3.0	E22108	6500	6060 T5	7.79
40 x 3.0 RAD	E73599	6500	6060 T5	7.70
45 x 2.5	E22109	6500	6060 T5	7.46
50 x 1.6	EQ2259	6500	6060 T5	5.43
50 x 1.6 RAD	EQ6446	6600	6060 T6	5.25
50 x 2.0	EB1003	6500	6060 T5	6.74
50 x 2.5	EL8008	6500	6060 T5	8.34
50 x 3.0	EB1004	6500	6060 T5	9.90
50.8 x 3.18 RAD	EL6217	6500	6060 T5	10.5
65 x 2.5	EQ6382	6500	6060 T5	11.0
65 x 3.0 RAD	EU2011	6500	6060 T5	13.1
75 x 3.0 RAD	EQ6032	6500	6060 T5	14.8
76 x 6.35 RAD	EQ4171	6000	6082 T6	26.4
76.2 x 6.35 RAD	E11077	6500	6005A T5	28.7
80 x 6 RAD	E22129	6000	6085 T5	28.8



Note: * Sizes not available in all states

Aluminium Angles

A	B	T	Die	Alloy / Temper	Length mm	Mass/LEN
20	20	1.6	EK9107	6060 T5	6500	1.07
20	20	3.0	EK9108	6060 T5	6500	1.95
25	12	1.6 RAD	EK9109	6060 T5	6500	0.65
25	20	1.6	EK9111	6060 T5	6500	1.22
25	25	1.6	EK9216	6060 T5	6500	1.36
25	25	3.0	EK9217	6060 T5	6500	2.48
32	20	1.6	EK9114	6060 T5	6500	1.42
32	32	1.6	EB1126	6060 T5	6500	1.75
32	32	3.0	EK9118	6060 T5	6500	3.21
40	20	1.6	EL3257	6060 T5	6500	1.64
40	20	3.0	EK9121	6060 T5	6500	3.00
40	25	1.6	EL8124	6060 T5	6500	1.78
40	25	3.0	EK9122	6060 T5	6500	3.26
40	40	1.6	EK9123	6060 T5	6500	2.20
40	40	3.0	EK9124	6060 T5	6500	4.06
40	40	6.0	EK9126	6060 T5	6500	7.79
50	25	1.6	EK9129	6060 T5	6500	2.06
50	25	3.0	EK9130	6060 T5	6500	3.79
50	40	3.0	EK9131	6060 T5	6500	4.58
50	50	1.6	EL9417	6060 T5	6500	2.76
50	50	3.0	EK9132	6060 T5	6500	5.11
50	50	6.0	EK9134	6060 T5	6500	9.90
50	50	6.0 RAD	EN5408	6060 T5	6000	9.19
60	60	3.0	EK9135	6060 T5	6500	6.61
60	60	6.0	EK9136	6060 T5	6500	12.0
70	25	1.6	EN5714	6060 T5	6500	2.61
70	40	1.6	EN7492	6060 T5	6500	3.04
75	25	3.0	EL5923	6060 T5	6500	5.12
76.2	50.8	6.35 RAD	EG6410	6060 T5	6000	12.8
76.2	76.2	3.2	E06168	6060 T5	6500	8.31
80	20	3.0	EK9137	6060 T5	6500	5.10
80	50	2.5	E20559	6060 T5	6500	5.60
80	80	6.0	EK9138	6060 T5	6500	16.2
100	50	3.0	EP12372	6060 T5	6500	7.74
100	50	4.0	E20525	6060 T5	6500	10.3
100	50	6.0 RAD	EQ1558	6060 T5	6500	14.1
100	100	6.0	EP12627	6060 T5	6500	18.9
125	50	3.0	EK9139	6060 T5	6500	9.06
125	50	6.0 RAD	E20700	6060 T5	6500	16.5



Note: * Sizes not available in all states

Aluminium Channels

A	B	C	T1	T2	Die	Alloy / Temper	Length mm	Mass/LEN
10	10	10	1.6		EK9146	6060 T5	6500	0.75
12	12	12	1.6		EK9149	6060 T5	6500	0.92
12	20	20	2.5		EK9151	6060 T5	6500	2.06
16	16	16	1.6		EK9152	6060 T5	6500	1.26
20	20	20	1.6		EL1812	6060 T5	6500	1.59
20	20	20	3		EK9155	6060 T5	6500	2.84
22.32	20	20	1.2 RAD		EN4619	6060 T5	6500	1.29
25	12	12	3		EK9156	6060 T5	6500	2.26
25	25	25	1.6		EL5249	6060 T5	6500	2.02
25	25	25	3		EK9158	6060 T5	6500	3.63
25	40	40	3		EK9159	6060 T5	6500	5.21
32	16	16	1.6		E20784	6060 T5	6500	1.70
32	25	25	3		EK9160	6060 T5	6500	4.00
40	20	20	2		EQ1556	6060 T5	6500	2.67
40	20	20	3		EK9161	6060 T5	6500	3.89
40	25	25	3		EK9162	6060 T5	6500	4.42
40	40	40	3		E20790	6060 T5	6500	6.00
44.45	25.4	25.4	3.18		EG1021	6060 T5	6500	4.96
50	25	25	3		EK9215	6060 T5	6500	4.95
50	50	50	3		EK9163	6060 T5	6500	7.58
53	25	25	1.5		E20830	6060 T5	6500	2.43
54.2	20	20	1.6		E20821	6060 T5	6500	2.56
60	32	32	3		EK9164	6060 T5	6500	6.21
76.2	38.1	38.1	RAD		EG6435	6060 T5	6500	16.4
80	25	25	3		EK9165	6060 T5	6500	6.53
80	40	40	4		EK9166	6060 T5	6500	10.7
80	40	40	4 RAD		E20921	6060 T5	6500	9.88
80	40	40	6 RAD		E20922	6060 T5	6500	14.5
100	25	25	3		EK9168	6060 T5	6500	7.58
100	50	50	3		EB1208	6060 T5	6500	10.2
100	50	50	5 RAD		EN3527	6060 T5	6500	19.5
100	50	50	6 RAD	9	EN3528	6060 T5	6500	26.6
100	50	50	7.56 RAD		EP13664	6060 T5	6500	#N/A
101.6	50.8	50.8	7.9 RAD	6.3	EG6434	6060 T5	6500	22.5



Note: * Sizes not available in all states

Aluminium Tees

Size mm x mm	Die	Length mm	Alloy / Temper	Mass/LEN
20 x 20 x 1.6	EK9140	4000	6060 T5	0.66
25 x 25 x 1.6	EK9142	6500	6060 T5	1.36
25 x 25 x 3.0	EK9143	6500	6060 T5	2.48
35 x 50 x 3.0 RAD	EU9284	6000	6082 T6	4.05
40 x 40 x 1.6	EL5287	6500	6060 T5	2.20
40 x 40 x 3.0	EK9144	6500	6060 T5	4.06
40 x 40 x 4.0 RAD	EU9187	6000	6082 T6	5.02
45 x 100 RAD	EU7074	9650	6082 T6	21.5
50 x 156 x 6.0 RAD	EU8408	9650	6082 T6	31.3
50 x 25 x 1.6	E20212	6500	6060 T5	2.06
50 x 50 x 4.0 RAD	E20219	6000	6082 T6	6.32
50 x 50 x 6.0 RAD	E20205	6000	6082 T6	9.31
50 x 60 RAD	EU6368	6000	6082 T6	8.47
50 x 70 RAD	EN5331	9650	6082 T6	17.1
80 x 139 RAD	EU7545	6000	6082 T6	21.7
80 x 163 RAD	EN5218	6000	6082 T6	23.6



Note: * Sizes not available in all states

Aluminium Round Bar

Diameter	Die	Length mm	Alloy / Temper	Mass/LEN
10	EX6000	4000	6060 T5	0.85
12	EX6001	4000	6060 T5	1.22
16	EX6002	4000	6060 T5	2.17
20	EX6003	4000	6060 T5	3.39
25.4	EX3000	4000	6060 T5	5.48
33	EX6005	4000	6061 T6	9.24
39	EX6006	4000	6061 T6	12.9



Note: * Sizes not available in all states

Aluminium Flat Bars

Size mm x mm	Die	Length mm	Alloy / Temper	Mass/LEN
20 x 3	EX4004	4000	6060 T5	0.65
20 x 6	EX4020	4000	6060 T5	1.30
25 x 3	EX4005	4000	6060 T5	0.81
25 x 6	EX4021	4000	6060 T5	1.62
32 x 3	EX4006	4000	6060 T5	1.04
32 x 6	EX4022	4000	6060 T5	2.07
32 x 10	EX4030	4000	6060 T5	3.46
40 x 3	EX4007	4000	6060 T5	1.30
40 x 6	EX4023	4000	6060 T5	2.59
40 x 10	EX4031	4000	6060 T5	4.32
50 x 3	EX4008	4000	6060 T5	1.62
50 x 6	EAL4035	4000	6060 T5	3.24
50 x 6 RAD	EX4024	4000	6060 T5	3.23
50 x 10	EX4032	4000	6060 T5	5.40
50 x 12	EX4039	4000	6060 T5	6.48
60 x 3	EX4009	4000	6060 T5	1.94
60 x 6	EX4069	4000	6060 T5	3.89
60 x 10	EX4070	4000	6060 T5	6.48
60 x 12	EX4040	4000	6060 T5	7.78
80 x 3	EX4010	4000	6060 T5	2.59
80 x 6	EX4025	4000	6060 T5	5.18
80 x 10	EX4033	4000	6060 T5	8.64
80 x 12	EX4041	4000	6060 T5	10.4
80 x 16	EX4044	4000	6060 T5	13.8
100 x 1.5 RAD	E34113	3750	6060 T5	1.52
100 x 3	EX4011	4000	6060 T5	3.24
100 x 6	EX4026	4000	6060 T5	6.48
100 x 10	EX4034	4000	6060 T5	10.8
100 x 12	EX4042	4000	6060 T5	13.0
160 x 6	EX4027	4000	6060 T5	10.4
160 x 10	EX4035	4000	6060 T5	17.3

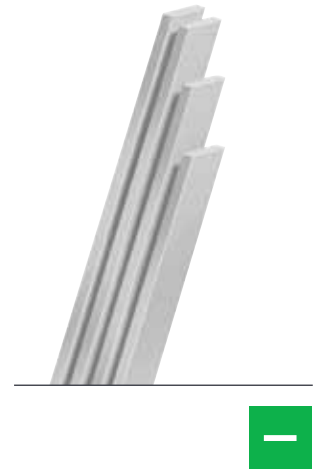

Note: * Sizes not available in all states

Aluminium Square Bars

Size mm x mm	Die	Length mm	Alloy / Temper	Mass/LEN
6 x 6	EX6500	4000	6060 T5	0.39
10 x 10	EX6501	4000	6059 T5	1.08
12 x 12	EX6502	4000	6060 T5	1.56
16 x 16	EX6503	4000	6060 T5	2.77
20 x 20	EX6504	4000	6060 T5	4.32
25 x 25	EX6505	4000	6060 T5	6.75
40 x 40	EX6506	4000	6106 T6	17.0

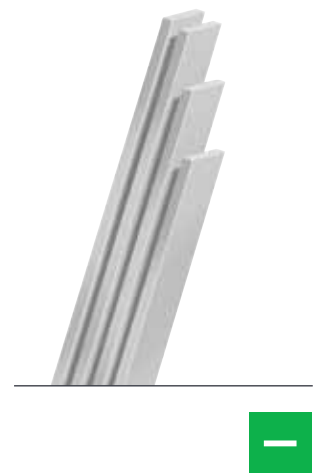

Note: * Sizes not available in all states

Aluminium Sheet and Plate

Sheet 5005 H34

Thickness mm	Width mm	Length mm	kg/sheet
0.60	1200	2400	4.66
0.80	1200	2400	6.22
1.00	1200	2400	7.78
1.20	1200	2400	9.33
1.60	1200	2400	12.4
2.00	1200	2400	15.5
2.00	1200	3000	19.4
2.00	1500	3600	29.2
2.50	1200	2400	19.4
3.00	1200	2400	23.3
3.00	1200	3000	29.2
3.00	1500	3000	36.3
3.00	1500	3600	43.7
4.00	1200	2400	31.1
5.00	1200	2400	38.9
6.00	1200	2400	46.6



Aluminium Sheet and Plate

PVC Coated 5005 H34

Thickness mm	Width mm	Length mm	kg/sheet
1.20	1200	2400	9.33
1.60	1200	2400	12.4
2.00	1200	2400	15.5
2.50	1200	2400	19.4
3.00	1200	2400	23.3



Aluminium Sheet and Plate

Grade	Thickness mm	Width mm	Length mm	kg/sheet
5052 H32	1.60	1200	2400	12.4
	2.00	1200	2400	15.4
	2.50	1200	2400	19.4
	3.00	1200	2400	23.3
5251 H34	2.50	1500	3000	30.2



Aluminium Tread Plate

3003 H22 - Propellor Bright

Thickness mm	Width mm	Length mm	kg/sheet
1.60	1219	2438	12.9
2.00	1219	2438	17.1
3.00	1219	2438	27.2
4.76	1219	2438	45.0



Aluminium Tread Plate

5052 H114 - 5BAR

Thickness mm	Width mm	Length mm	kg/sheet
1.60	1200	2400	13.2
2.00	1200	2400	17.0
2.00	1500	3000	26.5
2.50	1200	2400	21.3
2.50	1500	3000	33.3
3.00	1200	2400	25.3
3.00	1200	6000	63.4
3.00	1500	3000	39.6
3.00	1500	6000	80.3
4.00	1200	2400	33.1
4.00	1200	6000	82.4
4.00	1500	6000	103
5.00	1200	2400	39.7
5.00	1200	3660	62.0
5.00	1200	6000	102
5.00	1500	6000	127
6.00	1200	2400	47.8
6.00	1500	3000	74.7



Stainless Steel

Stainless Steel Angles

Grades 304, 316

Size mm x mm	Mass kg/m
25 x 25 x 3	1.13
25 x 25 x 5	1.77
25 x 25 x 6	2.06
30 x 30 x 3	1.36
30 x 30 x 5	2.17
30 x 30 x 6	2.53
30 x 30 x 5	1.02
30 x 30 x 6	1.21
40 x 40 x 3	1.85
40 x 40 x 5	2.98
40 x 40 x 6	3.49
50 x 50 x 3	2.36
50 x 50 x 5	3.79
50 x 50 x 6	4.46



Stainless Steel Sheet and Coil

Austenitic		
Grade	Thickness Range mm	Width mm
316	0.55 to 6.00	914, 1219, 1500, 1525
304	0.55 to 6.00	914, 1219, 1500, 1525

Ferritic		
Grade	Thickness Range mm	Width mm
430	0.55 to 0.9	914, 1219



Note: Range of Stainless Steel includes:
 Grades: 304, 304L, 316, 316L
 Finishes: 2B, No. 4 Polished, bright annealed

Stainless Steel Flat Bars

Grades 304, 316

Size mm x mm	Mass kg/m
12 x 3	0.29
12 x 6	0.58
20 x 3	0.49
20 x 5	0.81
20 x 6	0.98
25 x 3	0.61
25 x 5	1.02
25 x 6	1.21
25 x 10	2.04
25 x 12	2.45
32 x 3	0.77
32 x 5	1.30
32 x 6	1.57
32 x 10	2.62
40 x 3	0.98
40 x 5	1.61
40 x 6	1.96
40 x 10	3.27
40 x 12	3.92
50 x 3	1.21
50 x 5	2.04
50 x 6	2.45
50 x 10	4.08
50 x 12	4.90
65 x 5	2.61
65 x 6	3.18
65 x 10	5.31
75 x 5	3.06
75 x 6	3.68
75 x 10	6.04
75 x 12	7.25
100 x 6	4.91
100 x 10	8.18



Note: Range of Stainless Steel includes:
Grades: 304, 304L, 316, 316L

Stainless Steel Round Bars

Grades 304, 316 & 430

Size mm x mm	Mass kg/m
3.18	0.06
4.76	0.14
6.35	0.25
7.94	0.39
9.00	0.50
10.0	0.62
12.0	0.89
12.7	0.99
15.9	1.55
16.0	1.58
19.1	2.24
20.0	2.47
22.2	3.04
24.0	3.55
25.4	3.98
30.0	5.55
31.8	6.21
32.0	6.31
35.0	7.55
38.1	8.94
40.0	9.86
44.5	12.2
50.8	15.9
54.0	17.9
57.2	20.1
63.5	24.9
66.7	27.4
69.9	30.1
76.2	35.8
82.6	42.0
88.9	48.7
101.6	63.6
127	99.4



Walkway Systems



InfraBuild Steel Centre have partnered with leading suppliers Webforge and Nepean Building & Infrastructure to supply walkway systems as either fully prefabricated custom panels or as standard components. Grating, handrail and components are available in mild steel, aluminium, stainless steel, or corrosion/chemical resistant fibreglass reinforced plastic (FRP). Stanchion and handrail products are available in a range of mounting configurations to suit mounting for: platform, stairway, side mount, side offset, conveyor, cored, weld-on, or bolt-on style.



FRP Grating

FRP grating is composed of 65% resin and 35% continuous glass fibres, available in stock panels 3660 x 1220 with 6 mm load bar configurations in a range of depths and sizes in green or yellow and a grey "Mini-mesh". The high resin content makes FRP resistant to a wide range of corrosive chemicals, gases and fumes. Other properties that make FRP a valuable choice in dangerous work areas are its fire retardant, non-sparking, and non-conductive properties. FRP is simple to cut and assemble on site with standard tools. Ancillary items recommended for site assembly are stainless steel mounting brackets, and sealing kits to seal cut edges.

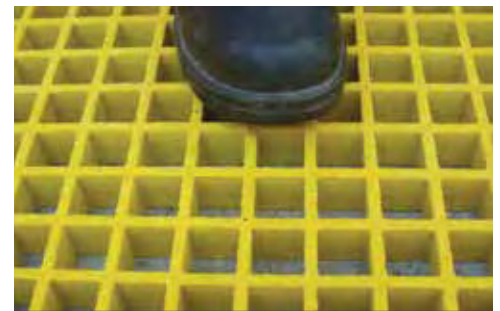

Drainage Grates

InfraBuild Steel Centre offers a range of standard (stock) and custom made mild steel drainage and trench grates that comply with AS3996.

Grates are rated to:

- Class A: Extra light duty – suit pedestrian/cyclists
- Class B: Light duty – suit light vehicles/tractors, livestock
- Class C: Medium duty – suit malls and pedestrian areas open to slow moving commercial vehicles
- Class D: Heavy Duty – suit roads and areas open to commercial vehicles



Composite Flooring

Composite flooring comprises of floorplate welded to the top of grating (shown right), and is available in mild steel or aluminium. Another option is a composite comprised of grating with a light gauge mesh welded to the underside to prevent tools or small objects from falling through the grating.

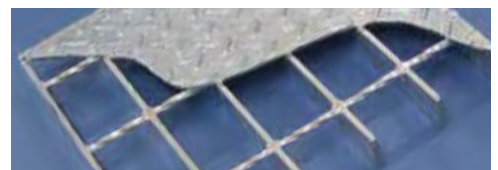

Expanded Walkway Mesh

Made from 5mm mild steel, walkway mesh is a strong, cost effective solution for high impact and load applications. 3000mm long panels are available in stock widths of 1200/900/750/600mm. 45mm SWM x 135mm LWM and 30mm SWM x 75mm LWM configurations available.



Stair Stringers

Weldlok® stair stringers are available configured for 2 to 17 treads. Treads and mounting brackets can be purchased separately. Advantages of pre-assembled stringers

- Convenient and easy to install
- Hot-dip galvanised to AS/NZS 4680
- Standard with 175mm rise and 250mm going at an angle of 35 degrees
- Designed to take a maximum tread width of 1000mm

How to calculate the number of treads required

1. Measure the vertical height from the ground to the finished floor level of the landing.
2. Divide the height by the rise (175mm)
3. Round the result to the nearest whole number, then reduce by 1 for the top landing.

i.e. Height = 1000 divided by 175 = 5.71 rounded to 6 and reduced by 1 = 5 step stringers required.

Weldlok® Product Code	Number of Steps	Vertical Height (mm)	RHS Thickness (mm)	Weight per Pair (kg)
G1TS	1	350	3.0	10
G2TS	2	525	3.0	15
G3TS	3	700	3.0	19
G4TS	4	875	3.0	25
G5TS	5	1050	3.0	30
G6TS	6	1225	4.0	35
G7TS	7	1400	4.0	41
G8TS	8	1575	4.0	46
G9TS	9	1750	4.0	52
G10TS	10	1925	4.0	58
G11TS	11	2100	4.0	61
G12TS	12	2275	4.0	66
G13TS	13	2450	5.0	107
G14TS	14	2625	5.0	116
G15TS	15	2800	5.0	124
G16TS	16	2975	5.0	132
G17TS	17	3150	5.0	140



Notes:

- * Treads must be >50mm thick
- * Treads must not be greater than 1000mm wide
- * When installing the stringers, in order to comply with the Building Code of Australia, the "rise" of each tread must be consistent, including the first step and the last step up to the landing platform. This may require the ground level to be built up.



NEPEAN
Building & Infrastructure

 Weldlok®

 Mastermesh®

 Galintel®

 Galserv®

Australia's leading integrated manufacturers of metal products www.nepean.com

Stair Treads

Stair treads are made to measure from mild steel, aluminium, stainless steel, or FRP with options of non slip nosing. Suitable for either bolt-on or weld-on attachment. Weldok® stair treads can be supplied in Series 30, 40 & 60 forgebar grating. Treads may be selected using the Recommended Width and Recommended Max. Length tables. Non-standard treads can also be supplied on request. Please consult our sales department.

Type T1	Type T2	Type T3	Type T4
Welded fixing, no nosing	Mild steel bolted fixing	Mild steel with floor plate nosing, welded fixing	Bolted fixing, floor plate nosing
Type T5	Type T6	FRP	
Aluminium with abrasive nosing, welded fixing	Bolted fixing, Holed End Plates, abrasive Nosing	FRP tread with abrasive nosing, bolted fixing	

Ordering Stair Treads

1. Select from the tread types shown (T1 to T6).
2. Refer to Recommended Max. Lengths table. Select a Load Bar Size and Series with a maximum length equal to or greater than the required tread length. For example, if the required tread length is 1100mm, the Series 40 grating with 32 x 5 load bars (A40-325) would be appropriate.
3. From the Recommended Widths table, choose a width that corresponds to the tread type and Series selected. For example, based on the Series 40 grating and a T1 tread, the tread width would be either 125, 165, 205, 245, 285 or 325mm. Example would be: Tread Type T1 ~ 1100 x 285 from A40 – 325

Recommended Maximum Lengths (mm)			
Load Bar Size	25 x 5	32 x 5	40 x 5
Series 30	900	1300	1600
Series 40	750	1200	1500
Series 60	500	800	1300

Recommended Widths (mm)							
Tread Types T1 to T6							
Series 30	125	155	185	215	245	275	305
Series 40	125	165		205	245	285	325
Series 60	125		185		245		305

Bolted Connections							
End Plate Hole Centres (mm)							
'A'	45	75	75	100	100	100	100

Standard Stocked Treads (serrated):
 600 x 285mm
 750 x 285mm
 900 x 245mm
 900 x 275mm

Standard End Plates for Bolted Threads

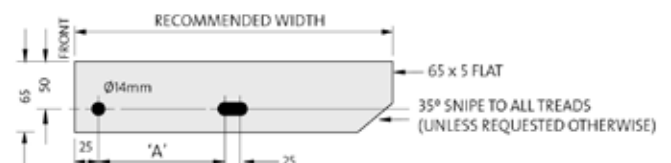

Note: Special End Plate Hole Centres available on request.

Non-Weld Handrail Systems

Top Rail



101 - Short Tee



104 - Long Tee



128 - Corner (Top Rail)



125 - 90 degree elbow

Suit Pipe	Product code	Suit Pipe	Product code	Suit Pipe	Product code	Suit Pipe	Product code
32NB	101-C42	32NB	104-C42	32NB	128-C42	32NB	125-C42
40NB	101-D48	40NB	104-D48	40NB	128-D48	40NB	125-D48
48NB/32NB	101-D48/C42	40NB	104-D48	40NB	128-D48	48NB/32NB	125-D48/C42

Middle Rail



116 - Corner (Middle Rail)



119 - Cross (Middle Rail)



150 - Internal Expanding Joint

Suit Pipe	Product code	Suit Pipe	Product code	Suit Pipe	Product code
32NB	116-C42	32NB	119-C42	32NB	150-C42
40NB	116-D48	40NB	119-D48	40NB	150-D48

Elbows & Knuckles



124 - Variable Elbow 15 - 60 degrees



166 - Adjustable knuckle



173 - Single Swivel Combination

Suit Pipe	Product code	Suit Pipe	Product code	Suit Pipe	Product code
32NB	124-C42	32NB	166-C42	32NB	173-C42
40NB	124-D48	40NB	166-D48	40NB	173-D48

Non-Weld Handrail Systems



Bases



232 - Heavy Duty Railing Base Flange



242 - Base Flange with Toe Board Fixing



246 - Heavy Duty Side Palm

Suit Pipe	Product code	Suit Pipe	Product code	Suit Pipe	Product code
32NB	232-C42	32NB	242-C42	32NB	246-C42
40NB	232-D48	40NB	242-D48	40NB	246-D48

Access Systems



745 - DDA Assist Expanding Wall Bracket



746 - DDA Assist Saddle Wall Bracket



766 - Adjustable elbow

Suit Pipe	Product code	Suit Pipe	Product code	Suit Pipe	Product code
32NB	745-C42	32NB	746-C42	32NB	766-C42
*Will also fit 40NB		*Will also fit 40NB		*Will also fit 40NB	

Note: In order to meet the requirements of accessibility standards, the range forms flush joints with size 32NB tube.





Build a better floor with a DuraGal Flooring System®



Whether you're building a deck or a whole house, the DuraGal Flooring System® is assembled on-site and requires no welding. Simple screwed connections make construction fast and easy.

DuraGal Flooring System® meets the industry durability guideline by including fully-galvanized Australian-made tubular sections, which are corrosion resistant and won't rot, warp or twist.

The strength of steel also allows for greater spans and reduces the impact of site works and sediment control issues.

DuraGal Flooring System[®]

DuraGal Flooring System[®] is a fully-engineered steel flooring system developed to provide a fire-and-termites-resistant, economical and easy-to-install alternative to conventional timber bearers and joists.

Easy to Install

DuraGal Flooring System[®] uses high strength C450L0 grade galvanized DuraGal[®] ZB135/135 Hollow Sections. The sections are strong and lightweight making them easy to handle on site. DuraGal[®] ZB135/135 is easy to cut and drill, and best of all the system has been designed so that it simply screws together on site using a screw gun fitted with a hex head bit. The DuraGal Flooring System[®] features a range of speciality galvanized fittings designed to allow you to get on with the job easily and quickly. Fast and accurate levelling of the floor using the adjustable piers during and after construction is a great feature. Sheet flooring can still be attached in the traditional way using

building adhesive and gun-nailing. Most reputable nail tool suppliers have hardened tipped nails to suit common nail guns to attach sheet flooring to steel joists up to and including 2mm thick.

Spans

Joists are typically 100 x 50 x 1.6mm with continuous spans of 2800mm and bearers are typically 150 x 50 x 2.0mm with continuous spans of 3000mm. Other sizes may be specified with differing spans subject to the floor layout and site conditions. Your DuraGal Flooring System[®] distributor will be able to nominate the most economical sizes and layout upon receipt of the house plans.

Note: DuraGal Flooring System[®] requires independent engineering certification to determine compliance of site specific conditions with statutory requirements.

Typical sections of DuraGal[®] ZB135/135

Piers: 90 x 90 x 2.0mm

Bearers: 150 x 50 x 2.0mm

Joists: 100 x 50 x 1.6mm

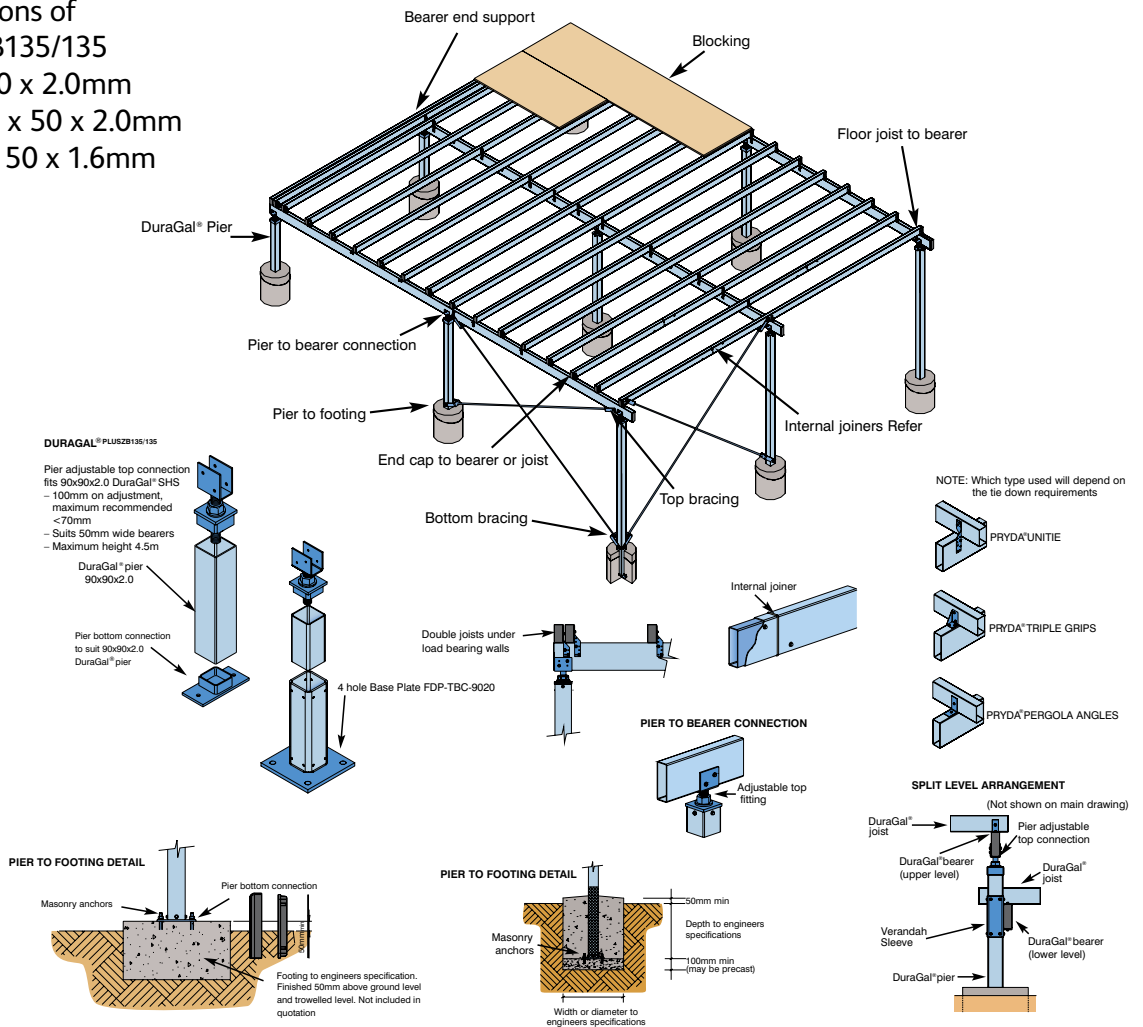

Mezzanine Flooring System

DuraGal® Mezzanine Flooring System

- A user friendly system that can save you time in construction, reducing the disruption to your business.
- On-site assembly without welding, only normal tools such as cut-off saws and Tek screw guns are required.
- High tensile strength and light weight sections allowing for a wider spacing of the bearers and, with the larger span distances between columns, under-floor areas are still usable with large open areas for uses such as workshops, office accommodation and storage areas etc.
- All connections are either screwed or nailed.
- Effectively increases storage capabilities
- Long lasting and virtually maintenance free
- Minimum fabrication required
- Minimum welding
- Low cost

DuraGal® Mezzanine Flooring System offers:

- A high strength, lightweight steel flooring system which can be used to increase the floor area of existing or new buildings.
- The system can also allow for the height of the columns to be adjusted, therefore compensating for any variations in the slab, with adjustment being available before or after installation.
- Columns, bearers and joists are all galvanised to be practically maintenance free.

DuraGal® Mezzanine Flooring System uses high strength C450L0 grade galvanised DuraGal® ZB135/135. The sections are strong and lightweight making them easy and safe to handle on site. The DuraGal® Mezzanine Flooring System is designed using a range of speciality fittings to allow safe and easy construction.

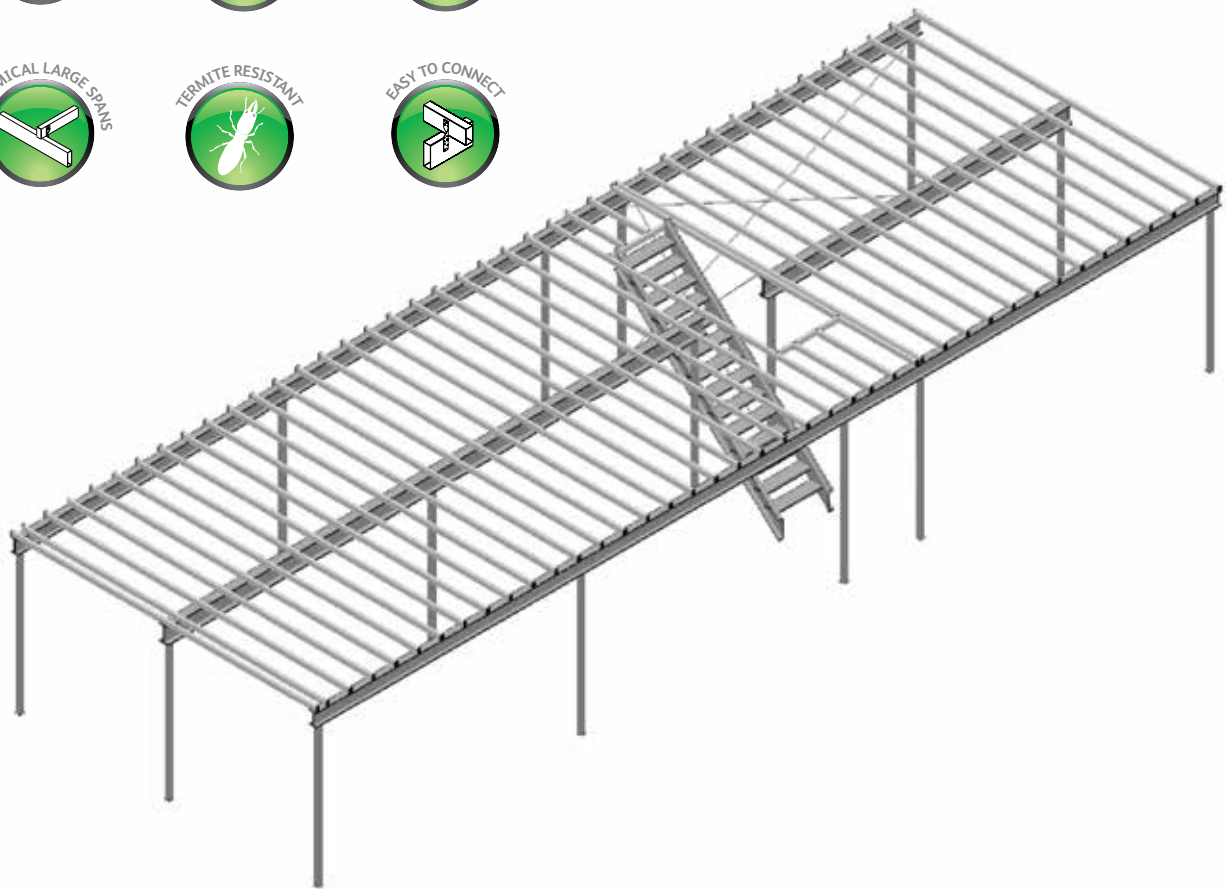

Lintels - Traditional

Quick Selection and Safe Load Tables

Category				
A	B	C	D	E
Description				
Non-load bearing brick veneer with separate structural timber frame	Cavity wall equally supported on both skins. (Supported roof span <8m)	Lightweight sheet roof and ceiling supported on single skin. (Supported roof span <8m)	Lightweight timber truss, tiled roof and sheet ceiling supported on single skin. (Supported roof span <8m)	Load-bearing internal brickwork under upper storeys. (Supported floor span <8m)

Traditional Angle 100 x 75 x 10 - 13kg/m	Category	Clear Span Length (mm)							
		* Follow the colour code from the loading categories above. Add end bearing of 100-150mm to both ends of span							
		900	1200	1500	1800	2100	2400	2700	3000
	A								
	B								
	C								
	D								
	E								

Traditional Angle 150 x 100 x 10 - 19kg/m	Category	Clear Span Length (mm)						
		* Follow the colour code from the loading categories above. Add end bearing of 100-150mm to both ends of span						
		2100	2400	2700	3000	3300	3600	4000
	A							
	B							
	C							
	D							
	E							

Note: InfraBuild Steel Centre reserve the right to change specifications without notice. Not all products are available at all InfraBuild Steel Centre branches. InfraBuild Steel Centre also has access to a wide network of products not necessarily listed in this book. Please check with your local InfraBuild Steel Centre branch for product availability.

Lintels - Traditional

Quick Selection and Safe Load Tables

Traditional Angle 100 x 75 x 10 - 13kg/m	Category	Clear Span Length (mm)						
		All tables are intended as a guide. Qualified expert advice should be sought in deciding the suitability of any structural product for a construction application. UDL = Uniform Distributed Load						
	Span (mm)	900	1200	1500	1800	2100	2400	2700
	Bar Length (mm)	1200	1500	1800	2100	2400	2700	3000
	Total Load (kg)	1345	1005	805	670	575	500	415
	UDL (kg/m)	1494	840	538	373	274	210	154
	Point Load (kg)	670	500	400	335	285	250	220

Traditional Angle 150 x 100 x 10 - 19kg/m	Category	Clear Span Length (mm)						
		All tables are intended as a guide. Qualified expert advice should be sought in deciding the suitability of any structural product for a construction application. UDL = Uniform Distributed Load						
	Span (mm)	1800	2100	2400	2700	3000	3300	3600
	Bar Length (mm)	2100	2400	2700	3000	3300	3600	4000
	Total Load (kg)	3205	2355	1800	1425	1150	950	800
	UDL (kg/m)	1781	1121	751	527	384	289	222
	Point Load (kg)	1690	1325	1010	800	645	535	450

• Loads limited by short term deflection of 1/600 span

Note: *Loads given are total (allowable) loads including lintel and brickwork.

Lintels - Flat and Angle

Quick Selection and Safe Load Tables

Category				
A	B	C	D	E
Description				
Non-load bearing brick veneer with separate structural timber frame	Cavity wall equally supported on both skins. (Supported roof span <8m)	Lightweight sheet roof and ceiling supported on single skin. (Supported roof span <8m)	Lightweight timber truss, tiled roof and sheet ceiling supported on single skin. (Supported roof span <8m)	Load-bearing internal brickwork under upper storeys. (Supported floor span <8m)

Flat Bar 85 x 7 - 5kg/m	Category	Clear Span Length (mm)												
		600	700	800	900	1200	1500	1800	2100	2400	2700	3000	3600	
	A													
	B													
	C													
	D													
	E													

Angle Bar 100 x 100 - 9kg/m	Category	Clear Span Length (mm)												
		600	700	800	900	1200	1500	1800	2100	2400	2700	3000	3600	
	A													
	B													
	C													
	D													
	E													

Angle Bar 150 x 100 - 12kg/m	Category	Clear Span Length (mm)												
		600	700	800	900	1200	1500	1800	2100	2400	2700	3000	3600	
	A													
	B													
	C													
	D													
	E													

Note: InfraBuild Steel Centre reserve the right to change specifications without notice. Not all products are available at all InfraBuild Steel Centre branches. InfraBuild Steel Centre also has access to a wide network of products not necessarily listed in this book. Please check with your local InfraBuild Steel Centre branch for product availability.

Lintels - Flat and Angle

Safe Load Tables

Flat Bar 85 x 7 - 5kg/m	Category	Clear Span Length (mm)				
		All tables are intended as a guide. Qualified expert advice should be sought in deciding the suitability of any structural product for a construction application. UDL = Uniform Distributed Load				
	Span (mm)	600	700	800	900	1000
	Bar Length (mm)	800	900	1000	1100	1200
	Total Load (kg)	43.7	32.1	24.5	19.4	15.7
	UDL (kg/m)	72.8	45.9	30.6	21.6	15.7
	Total Load (kg)	72.8	53.4	40.9	32.3	26.2
	UDL (kg/m)	121.3	76.3	51.1	35.9	26.2

Angle Bar 100 x 100 - 9kg/m	Category	Clear Span Length (mm)							
		All tables are intended as a guide. Qualified expert advice should be sought in deciding the suitability of any structural product for a construction application. UDL = Uniform Distributed Load							
	Span (mm)	1000	1200	1500	1800	2100	2400	2700	3000
	Bar Length (mm)	1200	1500	1800	2100	2400	2700	3000*	3300*
	Total Load (kg)	2083	1736	1265	878	645	486	384	311
	UDL (kg/m)	2083	1447	843	488	307	203	142	104
	Total Load (kg)	2083	1736	1389	1157	992	811	641	519
	UDL (kg/m)	2083	1447	926	643	472	338	237	173

Angle Bar 150 x 100 - 12kg/m	Category	Clear Span Length (mm)						
		All tables are intended as a guide. Qualified expert advice should be sought in deciding the suitability of any structural product for a construction application. UDL = Uniform Distributed Load						
	Span (mm)	1500	1800	2100	2400	2700	3000	3600
	Bar Length (mm)	1800	2100	2400	2700	3000	3300	4000
	Total Load (kg)	3024	2520	1993	1526	1206	976	676
	UDL (kg/m)	2016	1400	949	636	447	325	188
	Total Load (kg)	3024	2520	2100	1890	1680	1512	1312
	UDL (kg/m)	2016	1400	1000	788	622	504	364



• Loads not limited by deflection



• Loads limited by short term deflection of 1/600 span



• Loads limited by short term deflection of 1/360 span

C-Purlins

Designation	Size mm x mm x mm	Mass kg/m
C 10010	102 x 51 x 1.0	1.78
C 10012	102 x 51 x 1.2	2.10
C 10015	102 x 51 x 1.5	2.62
C 10019	102 x 51 x 1.9	3.29
C 15012	152 x 64 x 1.2	2.89
C 15015	152 x 64 x 1.5	3.59
C 15019	152 x 64 x 1.9	4.51
C 15024	152 x 76 x 2.4	5.70
C 20015	203 x 76 x 1.5	4.49
C 20019	203 x 76 x 1.9	5.74
C 20024	203 x 76 x 2.4	7.24
C 25019	254 x 76 x 1.9	6.50
C 25024	254 x 76 x 2.4	8.16
C 30024	300 x 96 x 2.4	10.1
C 30030	300 x 96 x 3.0	12.6
C 35030	350 x 125 x 3.0	15.1





Note: Purlins are made from high tensile steel to be fastened rather than welded. Purlins can be ordered pre-cut to length and with pre-punched holes or slots.

Z-Purlins

Designation	Web D (mm)	Thickness t (mm)	Flange E (mm)	Flange F (mm)	Flange L (mm)	Mass kg/m
Z 10010	102	1.0	53	49	12.5	1.78
Z 10012	102	1.2	53	49	12.5	2.10
Z 10015	102	1.5	53	49	13.5	2.62
Z 10019	102	1.9	53	49	14.5	3.29
Z 15012	152	1.2	66	61	15.5	2.89
Z 15015	152	1.5	66	61	16.5	3.59
Z 15019	152	1.9	66	61	17.5	4.51
Z 15024	152	2.4	70	60	19.5	5.70
Z 20015	203	1.5	77	74	15.0	4.49
Z 20019	203	1.9	80	74	18.5	5.74
Z 20024	203	2.4	82	73	21.5	7.24
Z 25019	254	2.4	79	74	18.0	6.50
Z 25024	254	2.4	79	73	21.0	8.16
Z 30024	300	2.4	105	93	27.0	10.1
Z 30030	300	3.0	107	93	31.0	12.6
Z 35030	350	3.0	134	121	30.0	15.1

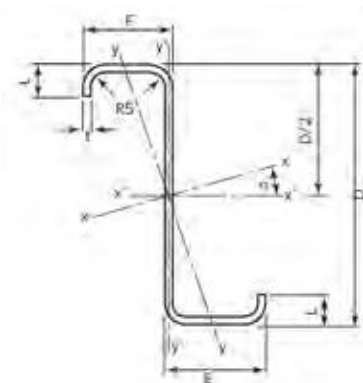



Note: Purlins are made from high tensile steel to be fastened rather than welded. Purlins can be ordered pre-cut to length and with pre-punched holes or slots.

Battens, Roofing and Walling

LYSAGHT TOPSPAN®

LYSAGHT TOPSPAN® has been used in the building and construction industry for many decades in commercial and residential applications. Applications include sheds, garages, carports, and as ceiling and roof battens as well as for handyman projects

TOPSPAN® 22

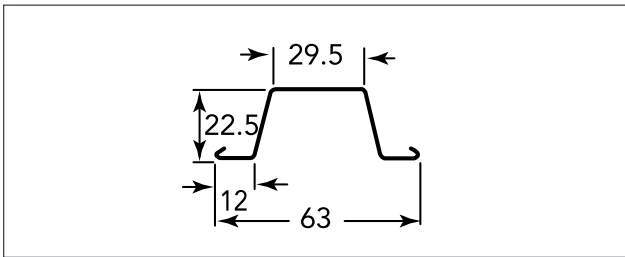

BMT mm	MASS kg/m	Yield Strength Mpa	Coating Mass g/m ²
0.42	0.35	550	150

Description

22mm deep batten ideal for use as a ceiling batten for internal fixing of ceiling or wall liner. (MPa minimum yield stress, 150g/m² minimum coating mass).

TOPSPAN® 40

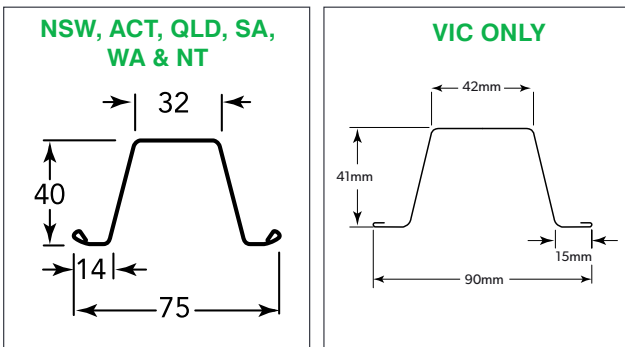

BMT mm	MASS kg/m	Yield Strength Mpa	Coating Mass g/m ²
0.48* (VIC ONLY)	0.60	550	150
0.55	0.67	550	150
0.75	0.91	550	150

Description

Ideal for use as a roofing batten for residential steel or tiled roof, TOPSPAN® 40 is a 40mm deep batten offering a high strength yet light weight solution that won't shrink, warp or twist.

TOPSPAN® 61

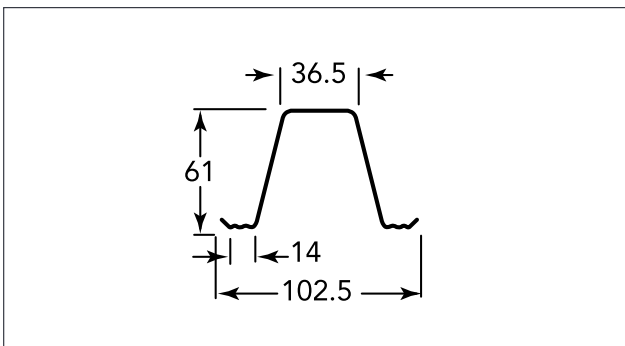

BMT mm	MASS kg/m	Yield Strength Mpa	Coating Mass g/m ²
0.60	0.95	550	125
0.75	1.18	550	125
1.00	1.56	550	125
1.20	1.87	550	125

Description

TOPSPAN® 61 is 61mm deep batten ideal for small framed shed and awning applications with a convenient size between that of a small purlin and large batten.

Battens, Roofing and Walling

TOPSPAN® 96* (QLD ONLY)

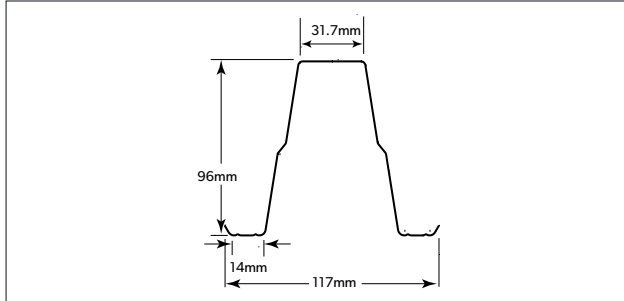

BMT mm	MASS kg/m	Yield Strength Mpa	Coating Mass g/m ²
0.75	1.68	550	125
1.00	2.22	550	125
1.20	2.66	550	125

Description

TOPSPAN® 96, available only in Queensland, is a 96mm deep roof purlin or wall girt ideal for sheds, garages, carports and awnings.

TOPSPAN® 120

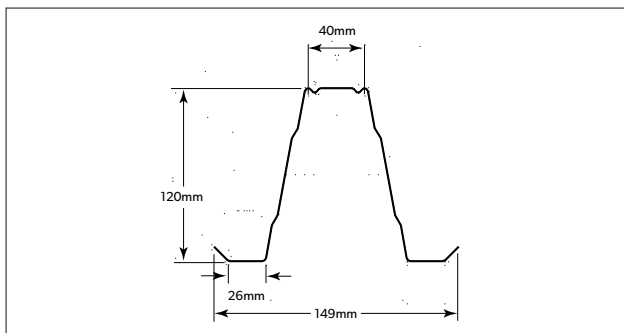

BMT mm	MASS kg/m	Yield Strength Mpa	Coating Mass g/m ²
0.70	2.07	550	125
0.90	2.64	550	125
1.00	2.93	550	125

Description

A 120mm deep roof purlin or wall girt, TOPSPAN® 120 is commonly used in rural, residential and small commercial applications for sheds, garages and awnings where longer spans or strength is required.



At **InfraBuild Steel Centre** our complete one-stop-shop saves you time and reduces complexity and risk on your next building project. We take your plans and provide a full-service solution: take offs, estimation, technical support, scheduling and delivery for all steel requirements. Our quality manufactured products give you confidence, because they meet relevant Australian Standards and Building Codes. Enquire with us today about how we can help you deliver your next building project on time and on budget.

Call your local branch to discuss your requirements

Flashings



Ridge Cap

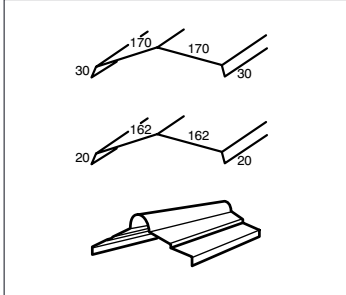

Description	Stock lengths mm
Ridge Capping RC1	1800
	2400
Ridge Capping RC2	1800
	2400
Ridge Roll Top RC3	1800
	2400

Note: Stock lengths and custom cut. Available in Zinalume® and Colorbond®. For fasteners refer to page 115.

Barge Mould/Corner Mould

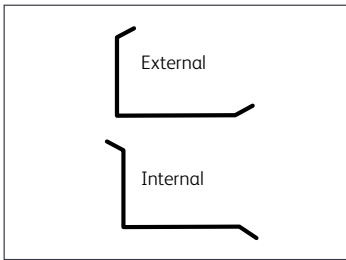

Size mm	Stock lengths mm
External – 75 x 75	1800 & 2400
External – 100 x 100	1800 & 2400
Internal – 150 x 100	1800 & 2400
Internal – 150 x 150	1800 & 2400

Note: Stock lengths and custom cut. Available in Zinalume® and Colorbond®. For fasteners refer to page 115.

Barge Capping/Parapet

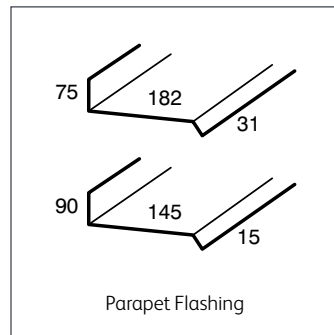
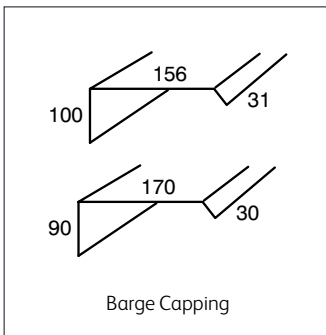

Description	Profile	Stock lengths mm
Barge Capping	Spandek Hi-Ten	1800 & 2400
	Custom Orb	1800 & 2400
	Trimdek Hi-Ten	1800 & 2400
Parapet Flashing	Spandek Hi-Ten	1800 & 2400
	Custom Orb	1800 & 2400
	Trimdek Hi-Ten	1800 & 2400

Note: Stock lengths and custom cut. Available in Zinalume® and Colorbond®. For fasteners refer to page 115.

COLORBOND® Steel Colour Range

Standard Colour Range



Basalt®

Classic
Cream™

Cottage Green®

Cove™

Deep Ocean®

Dune®

Evening Haze®



Gully™

Ironstone®

Jasper®

Mangrove®

Manor Red®

Monument®

Night Sky®

Pale
Eucalypt®

Paperbark®

Shale Grey™

Surfmist®

Terrain®

Wallaby®

Windspray®

Woodland
Grey®

Matt Colour Range



Basalt®

Dune®

Monument®

Shale Grey™

Surfmist®

The printed steel colours shown here have been reproduced to represent actual colours as accurately as possible. However we recommend checking your chosen colour against an actual product sample before purchasing as varying light conditions and print limitations affect colour tones.

Rainwater Products

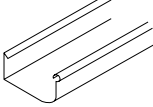
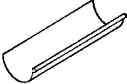
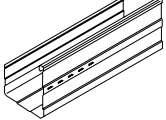
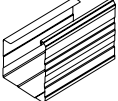
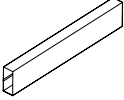
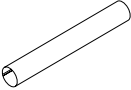
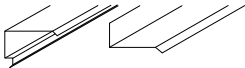
Product Image	Description	Dimensions mm
	Stramit® Quad Gutter	Various sizes
	Stramit® Half Round Gutter	Various sizes
	Stramit® M Pattern Gutter	85 x 123 x 140 front (QLD, NSW only)
	Stramit® Fascia Gutter	25 x 90 x 127, 140 front (VIC, TAS only)
	Stramit® Downpipe Rectangular	100 x 50, 100 x 75, 100 x 100, 100 x 150
	Stramit® Downpipe Round	Diameter: 50, 65, 75, 90, 100
	Stramit® Flashings	Various sizes

Note: For fasteners refer to page 115.

® Registered trademark of Stramit Corporation Pty Limited trading as Stramit Building Products ABN 57 005 010 195. A Member of the Fletcher Building Group. COLORBOND® and ™ are trade marks of BlueScope Steel Limited.

Structural Products



Product Image	Description	Dimensions mm
	Stramit Condeck HP®	0.75 & 1.00 BMT, 300mm Cover 55mm Rib Height
	Stramit® Edgeforma	Various sizes
	Stramit PrimeForm™	0.60 & 0.75 BMT (VIC only)
	Stramit® C & Z Purlins	Various sizes
	Stramit® Top Hats	64 x 34 x 20 x 6, 96 x 34 x 20 x 6, 120 x 42 x 27 x 10 (A x B x C x D)
	Stramit® Flooring	Various sizes
	Stramit® Roof Batten Stramit® Ceiling Batten	40 x 40 x 15 x 6.0m & 7.5m Length 6.1m
	Brackets & Angle Connectors	Various sizes

® Registered trademark of Stramit Corporation Pty Limited trading as Stramit Building Products ABN 57 005 010 195. A Member of the Fletcher Building Group. COLORBOND® and ™ are trade marks of BlueScope Steel Limited.

Note: InfraBuild Steel Centre reserve the right to change specifications without notice. Not all products are available at all InfraBuild Steel Centre branches. InfraBuild Steel Centre also has access to a wide network of products not necessarily listed in this book. Please check with your local InfraBuild Steel Centre branch for product availability.

Roofing and Walling

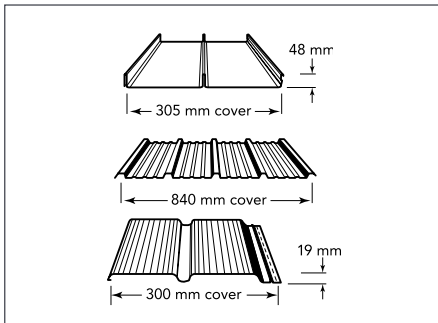

Description	Application	BMT Base Metal Thickness mm	Width of Coverage mm
Longline 305	Roofing	0.7	305
Multiclad	Walling	0.42	840
Easyclad	Walling	0.42	300

Note: For fasteners refer to page 115.

Gutters and Fascia

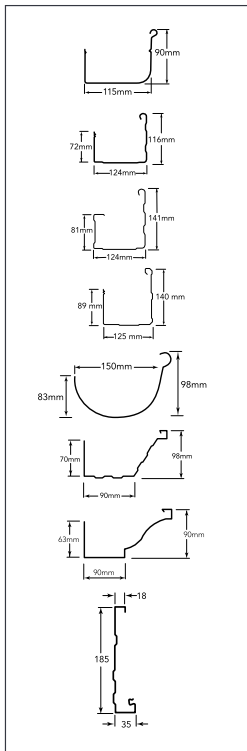

Product	Availability	Dimensions (mm)		
		A	B	C
Quad 115 Hi Front	QLD, SA, NSW, VIC, TAS	62	90	115
Trimline	QLD, Nth NSW, VIC, TAS	72	116	124
Sheerline	except QLD	81	141	124
Emline	QLD	89	125	140
Half Round	except NT		150	
Ranceline	WA	70	90	98
Colonial	WA	63	90	90
Novaline	QLD, SA, NSW, VIC, TAS, WA	18	185	35

Note: For fasteners refer to page 115.

Structural Decking

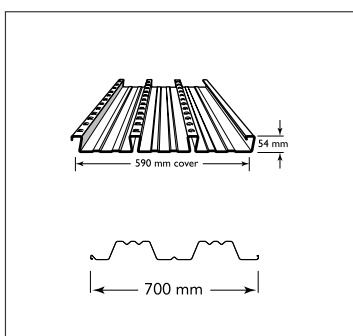

Description	BMT Base Metal Thickness mm	Mass kg/m ²	Width of Coverage mm
Bondek Plus	0.6	8.52	600
Bondek Plus	0.75	10.5	600
Bondek Plus	1	13.79	600

Note: For fasteners refer to page 115.

Note: InfraBuild Steel Centre reserve the right to change specifications without notice. Not all products are available at all InfraBuild Steel Centre branches. InfraBuild Steel Centre also has access to a wide network of products not necessarily listed in this book. Please check with your local InfraBuild Steel Centre branch for product availability.

Fencing

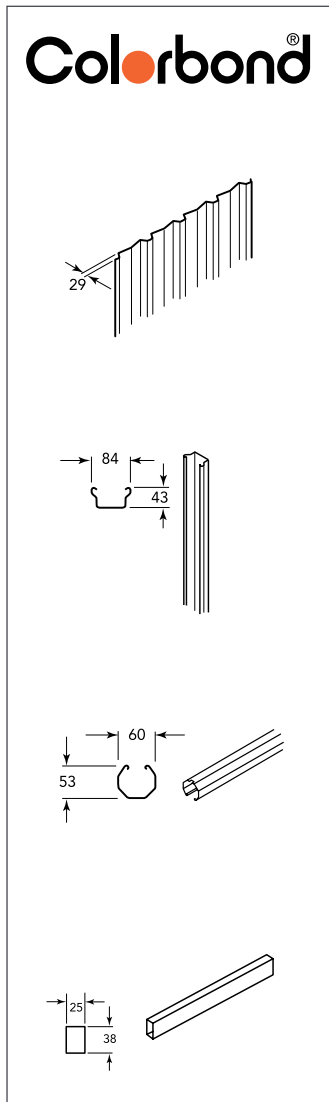

Note: Miniscreen not available in SA. Customscreen available in QLD and SA only.

Neetascreen		Smartascreen		Miniscreen		Customscreen	
Infill Sheet							
Dimension	Qty	Dimension	Qty	Dimension	Qty	Dimension	Qty
Height mm	3	Height mm	3	Height mm	3	Height mm	3
1190 (non std)		1190 (non std)		1190 (non std)		1190 (non std)	
1490		1490		1490		1490	
1790		1790		1790		1790	
2090		2090		2090		2090	
Non-standard		Non-standard		Non-standard		Non-standard	
Post							
Dimension	Qty	Dimension	Qty	Dimension	Qty	Dimension	Qty
Height mm	2	Height mm	2	Height mm	2	Height mm	2
2100		2100		2100		2100	
2400		2400		2400		2400	
2700		2700		2700		2700	
3000		3000		3000		3000	
Rails							
Dimension	Qty	Dimension	Qty	Dimension	Qty	Dimension	Qty
Universal Rail	2	Universal Rail	2	Miniscreen Rail	2	Customscreen Rail	2
Length mm		Length mm		Length mm		Length mm	
2350		2350		2350		2370	
3100 <small>(raked panels only)</small>		3100 <small>(raked panels only)</small>		3100 <small>(raked panels only)</small>		3100 <small>(raked panels only)</small>	
Miniscreen Centre Rail							
Dimension	Qty	Dimension	Qty	Dimension	Qty	Dimension	Qty
Length mm							
2350							
3100 <small>(raked panels only)</small>							
Fasteners							
Dimension	Qty	Dimension	Qty	Dimension	Qty	Dimension	Qty
Metal Tek Hex Head 10-16 x 16 (no neo)	17	Metal Tek Hex Head 10-16 x 16 (no neo)	17	Metal Tek Hex Head 10-16 x 16 (no neo)	17	Metal Tek Hex Head 10-16 x 16 (no neo)	17
				Ripple Tek Hex 10 x 16-20	7		
Post Cap							
Dimension	Qty	Dimension	Qty	Dimension	Qty	Dimension	Qty

Standard Fencing Colour Range

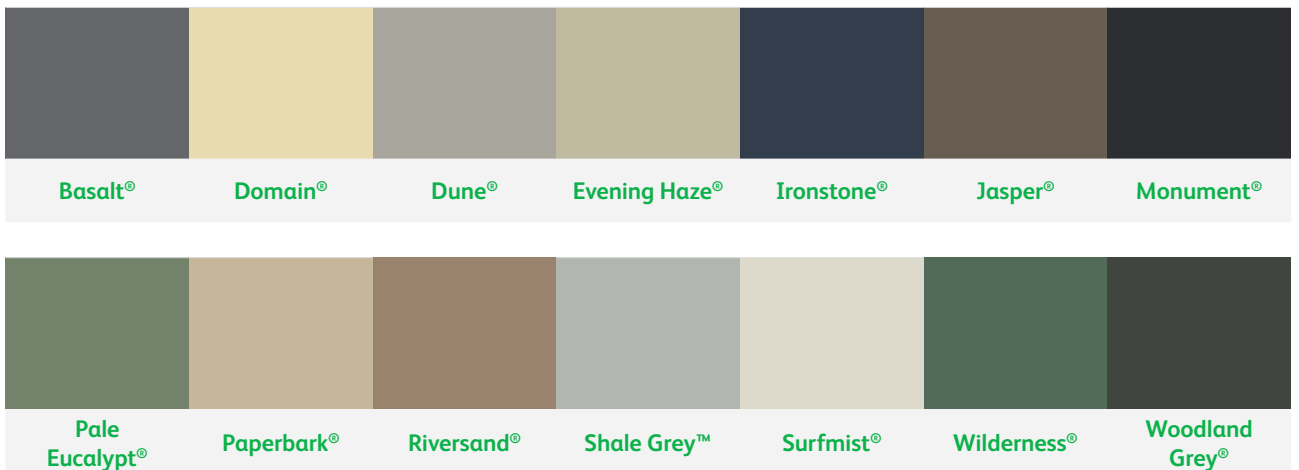

Note: InfraBuild Steel Centre reserve the right to change specifications without notice. Not all products are available at all InfraBuild Steel Centre branches. InfraBuild Steel Centre also has access to a wide network of products not necessarily listed in this book. Please check with your local InfraBuild Steel Centre branch for product availability.

Steel Pipes to American Standards

Nominal Size		Outside Diameter	Nominal Wall Thicknesses & Weights for Welded & Seamless Steel Pipe ASME B36.10									KEY: Dimensions - mm (Black) Weight - kg/m (Green)				
Dn	Nps	Mm	Std	Extra Strong	XX Strong	Sched. 10	Sched. 20	Sched. 30	Sched. 40	Sched. 60	Sched. 80	Sched. 100	Sched. 120	Sched. 140	Sched. 160	
6	1/8	10.3	1.73 0.37	2.41 0.47	-	-	-	-	1/3 0.37	-	2.41 0.47	-	-	-	-	
8	1/4	13.7	2.24 0.63	3.02 0.80	-	-	-	-	2.24 0.63	-	3.02 0.80	-	-	-	-	
10	3/8	17.1	2.31 0.84	3.2 1.10	-	-	-	-	2.31 0.84	-	3.2 1.10	-	-	-	-	
15	1/2	21.3	2.77 1.27	3.73 1.62	7.47 2.55	-	-	-	2.77 1.27	-	3.73 1.62	-	-	-	4.78 1.95	
20	3/4	26.7	2.87 1.69	3.91 2.20	7.82 3.64	-	-	-	2.87 1.69	-	3.91 2.20	-	-	-	5.56 2.90	
25	1	33.4	3.38 2.50	4.55 3.24	9.09 5.45	-	-	-	3.38 2.50	-	4.55 3.24	-	-	-	6.35 4.24	
32	1-1/4	42.2	3.56 3.39	4.85 4.47	9.7 7.77	-	-	-	3.56 3.39	-	4.85 4.47	-	-	-	6.35 5.61	
40	1-1/2	48.3	3.68 4.05	5.08 5.41	10.15 9.56	-	-	-	3.68 4.05	-	5.08 5.41	-	-	-	7.14 7.25	
50	2	60.3	3.91 5.44	5.54 7.48	11.07 13.44	-	-	-	3.91 5.44	-	5.54 7.48	-	-	-	8.74 11.11	
65	2-1/2	73.0	5.16 8.63	7.01 11.41	14.02 20.39	-	-	-	5.16 8.63	-	7.01 11.41	-	-	-	9.53 14.92	
80	3	88.9	5.49 11.29	7.62 15.27	15.24 27.67	-	-	-	5.49 11.29	-	7.62 15.27	-	-	-	11.13 21.35	
90	3-1/2	101.6	5.74 13.57	8.08 18.63	-	-	-	-	5.74 13.57	-	8.08 18.63	-	-	-	-	
100	4	114.3	6.02 16.07	8.56 22.32	17.12 41.03	-	-	-	6.02 16.07	-	8.56 22.32	-	11.13 28.32	-	13.49 33.54	
125	5	141.3	6.55 21.77	9.53 30.91	19.05 57.43	-	-	-	6.55 21.77	-	9.53 30.97	-	12.7 40.28	-	15.88 49.11	
150	6	168.3	7.11 28.26	10.97 42.56	21.95 79.22	-	-	-	7.11 28.26	-	10.97 42.56	-	14.27 54.20	-	18.26 67.56	
200	8	219.1	8.18 45.55	12.7 64.64	22.23 107.92	-	6.35 33.31	7.04 36.81	8.18 42.55	10.31 53.08	12.7 64.65	15.09 75.92	18.26 90.44	20.62 100.92	23.01 111.27	
250	10	273.1	9.27 60.31	12.7 81.55	25.4 155.15	-	6.35 41.77	7.8 51.03	9.27 60.31	XS 81.55	15.09 96.01	18.26 114.75	21.44 133.06	XXS 155.15	28.58 172.33	
300	12	323.9	9.53 73.88	12.7 186.97	25.4 186.97	-	6.35 49.73	8.38 65.20	10.31 79.73	14.27 108.96	17.48 132.08	21.44 159.91	XXS 186.97	28.58 208.14	33.32 238.76	
350	14	355.6	9.53 93.27	12.7 107.10	-	6.35 54.99	7.92 67.90	Std. W.T. 81.33	11.13 94.55	15.09 126.70	19.05 158.10	23.83 194.96	27.79 224.65	31.75 253.56	35.71 281.70	
400	16	406.4	9.53 93.27	12.7 123.30	-	6.35 62.64	7.92 77.83	Std. W.T. 93.27	XS 123.50	16.66 160.12	21.44 203.53	26.19 245.56	30.96 286.64	36.53 333.19	40.49 365.35	
450	18	457	9.53 105.16	12.7 139.15	-	6.35 70.57	7.92 87.71	11.13 122.38	14.27 155.80	19.05 205.74	23.83 254.55	29.36 309.62	34.93 363.56	39.67 408.26	45.24 365.35	
500	20	508	9.53 117.15	12.7 155.12	-	6.35 78.55	Std. W.T. 117.15	XS 155.12	15.09 183.42	20.62 247.83	26.19 311.17	32.54 381.53	38.1 441.49	44.45 508.11	50.01 564.81	
550	22	559	9.53 129.13	12.7 171.09	-	6.35 86.54	Std. W.T. 129.13	SX 171.09	-	22.23 294.25	28.58 373.83	34.93 451.42	41.28 527.05	47.63 600.63	53.98 672.26	
600	24	610	9.53 141.12	12.7 187.06	-	6.35 94.53	Std. W.T. 141.12	14.27 209.64	17.48 255.41	24.61 355.26	30.96 442.08	38.89 547.71	46.02 640.03	52.37 720.15	59.54 808.22	
650	26	660	9.53 152.87	12.7 202.72	-	7.92 127.36	XS 202.72	-	-	-	-	-	-	-	-	
700	28	711	9.53 164.85	12.7 218.69	-	7.92 137.31	XS 218.69	15.88 271.21	-	-	-	-	-	-	-	
750	30	762	9.53 176.84	12.7 234.67	-	7.92 147.28	XS 234.67	15.88 292.18	-	-	-	-	-	-	-	
800	32	813	9.53 188.82	12.7 250.64	-	7.92 157.24	XS 250.64	15.88 312.15	17.48 342.91	-	-	-	-	-	-	
850	34	864	9.53 200.31	12.7 266.61	-	7.92 167.20	XS 266.61	15.88 332.12	17.48 364.90	-	-	-	-	-	-	
900	36	914	9.53 212.56	12.7 282.27	-	7.92 176.96	XS 282.27	15.88 351.7	19.05 420.42	-	-	-	-	-	-	
1050	42	1067	9.53 248.52	12.7 330.19	-	-	-	-	-	-	-	-	-	-	-	

Formula to attain approximate mass in kilograms per metre (kg/m) for Steel Round Pipe and Tubing

$$m = (D - t) \times 0.02466$$

Where: m = mass to the nearest 0.01 kg/m
 D = Outside Diameter in millimetres
 (to nearest 0.1mm for OD up to 406.4mm)
 (to nearest 1.0mm for OD 457mm and above)
 t = Wall thickness to nearest 0.01mm

Example

nominal Size
 Dn300 nPS12
 OD = 323.9mm
 W.t. = 9.53mm

Step 1. 323.9 - 9.53 = 314.37
 Step 2. 314.37 x 9.53 = 2995.9461
 Step 3. 2995.9461 x 0.02466
 = 73.88kg/m

Stainless Steel Pipes to American Standards

Nominal Size (DN)	Outside Diameter mm	Nominal Wall Thickness & Inside Diameter (mm) for Stainless Steel Pipe ASME B36.19							
		Schedule 55		Schedule 105		Schedule 405		Schedule 805	
		Wall Thickness	Inside Diameter	Wall Thickness	Inside Diameter	Wall Thickness	Inside Diameter	Wall Thickness	Inside Diameter
6	10.29	–	–	1.24	7.81	1.73	6.83	2.41	5.47
8	13.72	–	–	1.65	10.42	2.24	9.24	3.02	7.68
10	17.15	–	–	1.65	13.85	2.31	12.53	3.2	10.75
15	21.34	1.65	18.04	2.11	17.12	2.77	15.8	3.73	13.88
20	26.67	1.65	23.37	2.11	22.45	2.87	20.93	3.91	18.85
25	33.4	1.65	30.1	2.77	27.86	3.38	26.64	4.55	24.3
32	42.16	1.65	38.86	2.77	36.62	3.56	35.04	4.85	32.46
40	48.26	1.65	44.96	2.77	42.72	3.68	40.9	5.08	38.1
50	60.33	1.65	57.03	2.77	54.79	3.91	52.51	5.54	49.25
65	73.03	2.11	68.81	3.05	66.93	5.16	62.71	7.01	59.01
80	88.9	2.11	84.68	3.05	82.8	5.49	77.92	7.62	73.66
100	114.3	2.11	110.08	3.05	108.2	6.02	102.26	8.56	97.18
125	141.3	2.77	135.76	3.4	134.5	6.55	128.19	9.52	122.25
150	168.28	2.77	162.74	3.4	161.47	7.11	154.05	10.97	146.33
200	219.08	2.77	213.54	3.76	211.56	8.18	202.72	12.7	193.68
250	273.05	3.4	266.24	4.19	264.67	9.27	254.51	12.70*	247.65
300	323.85	3.96	315.93	4.57	314.71	9.52	304.08	12.70*	298.45
350	355.6	3.96	347.68	4.78	346.05	–	–	–	–
400	406.4	4.19	398.02	4.78	396.85	–	–	–	–
450	457.2	4.19	448.82	4.78	447.65	–	–	–	–
500	508	4.78	498.45	5.54	496.93	–	–	–	–
600	609.6	5.54	598.53	6.35	596.9	–	–	–	–
750	762	6.35	749.3	7.92	746.16	–	–	–	–

Innovative Mechanical Pipe Joining Solutions



Victaulic® manufactures a range of innovative pipe joining and flow control solutions with benefits including:

- Safer and faster installation
- Lower total installed cost
- Significantly reduced downtime
- Reduced operational costs
- Versatility of design
- Reusable parts help to expedite maintenance

Speak to the team at InfraBuild Steel Centre about a Victaulic® solution to suit your application.



Call your local branch to discuss your requirements

Note: InfraBuild Steel Centre reserve the right to change specifications without notice. Not all products are available at all InfraBuild Steel Centre branches. InfraBuild Steel Centre also has access to a wide network of products not necessarily listed in this book. Please check with your local InfraBuild Steel Centre branch for product availability.

Carbon Steel Butt weld Fittings

Nom. Size DN	Pipe OD mm	Wall Thickness (mm) for Butt weld Fittings to ASME B16.19, B16.28 and BS.1640													A	B	K	D	V	E. Std. Wt. & Ex Stg	Nom. Size DN
		Sch. 10	Sch. 20	Sch. 30	Std. Wt.	Sch. 40	Sch. 60	X Stg	Sch. 80	Sch. 100	Sch. 120	Sch. 140	Sch. 160	X.X. Stg							
15	21.3	-	-	-	2.77	-	-	3.73	-	-	-	-	4.78	7.47	38	16	47.5	-	-	25.4	15
20	26.7	-	-	-	2.87	-	-	3.91	-	-	-	-	5.56	7.82	38	19	43	19	33	25.4	20
25	33.4	-	-	-	3.38	-	-	4.55	-	-	-	-	6.35	9.09	38	22	55.5	25.4	41	38.1	25
32	42.2	-	-	-	3.56	-	-	4.85	-	-	-	-	6.35	9.7	47.5	25.4	70	32	52	38.1	32
40	48.3	-	-	-	3.68	-	-	5.08	-	-	-	-	7.14	10.15	57	29	82.5	38	62	38.1	40
50	60.3	-	-	-	3.91	-	-	5.54	-	-	-	-	8.74	11.07	76	35	106	51	81	38.1	50
65	73	-	-	-	5.16	-	-	7.01	-	-	-	-	9.53	14.02	95	44.5	132	63.5	100	38.1	65
80	88.9	-	-	-	5.49	-	-	7.62	-	-	-	-	11.13	15.24	114	51	159	76	121	50.8	80
90	101.6	-	-	-	5.74	-	-	8.08	-	-	-	-	-	16.15	133	57	184	89	140	63.5	90
100	114.3	-	-	-	6.02	-	-	8.56	-	11.13	-	13.49	17.12	152	63.5	210	102	159	63.5	100	100
125	141.3	-	-	-	6.55	-	-	9.53	-	12.7	-	15.88	19.05	190	79	262	127	197	76.2	125	125
150	168.3	-	-	-	7.11	-	-	10.97	-	14.27	-	18.26	21.95	229	95	313	152	237	88.9	150	150
200	219.1	-	6.35	7.04	8.18	-	10.31	12.7	-	15.09	18.26	20.62	23.01	22.23	305	127	414	203	313	102	200
250	273.1	-	6.35	7.8	9.27	-	12.7	12.7	15.09	18.26	21.44	25.4	28.58	25.4	381	159	517	254	390	127	250
300	323.9	-	6.35	8.38	9.53	10.31	14.27	12.7	17.48	21.44	25.4	28.58	33.32	25.4	457	190	619	305	467	152	300
350	355.6	6.35	7.92	9.53	9.53	11.13	15.09	12.7	19.05	23.83	27.79	31.75	35.71	-	533	222	711	356	533	165	350
400	406.4	6.35	7.92	9.53	9.53	12.7	16.66	12.7	21.44	26.19	30.96	36.53	40.49	-	610	254	813	406	610	178	400
450	457	6.35	7.92	11.13	9.53	14.27	19.05	12.7	23.83	29.36	34.93	39.67	45.24	-	686	286	914	457	686	203	450
500	508	6.35	9.53	12.7	9.53	15.09	20.62	12.7	26.19	32.54	38.1	44.45	50.01	-	762	318	1016	508	762	229	500
600	610	6.35	9.53	14.27	9.53	17.48	24.61	12.7	30.96	38.89	46.02	52.37	59.54	-	914	381	1219	610	914	267	600
750	762	7.92	12.7	15.88	9.53	-	-	12.7	-	-	-	-	-	-	1143	470	1524	762	1143	267	750
900	914	7.92	12.7	15.88	9.53	19.05	-	12.7	-	-	-	-	-	-	1372	565	-	914	1372	267	900

B16.9

Long radius welding elbows, return bends & caps

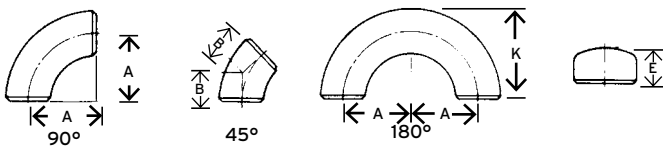
B16.28

Radius welding elbows, return bends

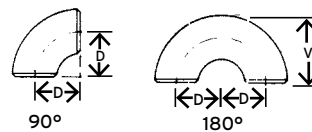
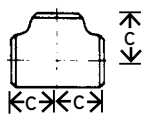

Straight tees (b16.9)

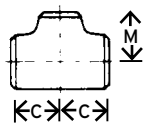
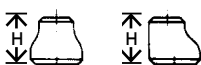
Nominal Size DN	Nominal Size			C	M	H	Nominal Size			C	M	H	Nominal Size		
	Large End	Small End	DN				Large End	Small End	DN				Large End	Small End	DN
20	20	20	28.6	-	-	100	100	105	-	-	400	400	305	-	-
	15	28.6	28.6	38.1	-	90	90	105	102	102		350	305	305	356
25	25	38.1	-	-	-	80	105	98.4	102	102		300	305	295	356
	20	38.1	38.1	50.8	-	65	105	95.3	102	102		250	305	283	356
	15	38.1	38.1	50.8	-	50	105	88.9	102	102		200	305	273	356
32	32	47.6	-	-	-	40	105	85.7	102	102		150	305	264	356
	25	47.6	47.6	50.8	-	125	125	124	-	-	450	450	343	-	-
	20	47.6	47.6	50.8	-	100	124	117	127	127		400	343	330	381
	15	47.6	47.6	50.8	-	90	124	114	127	127		350	343	330	381
40	40	57.2	-	-	-	80	124	111	127	127		300	343	321	381
	32	57.2	57.2	63.5	-	65	124	108	127	127		250	343	308	381
	25	57.2	57.2	63.5	-	50	124	105	127	127		200	343	298	381
	20	57.2	57.2	63.5	-	150	150	143	-	-	500	500	381	-	-
	15	57.2	57.2	63.5	-	125	143	137	140	140		450	381	368	508
50	50	63.5	-	-	-	100	143	130	140	140		400	381	356	508
	40	63.5	60.3	76.2	-	90	143	127	140	140		350	381	356	508
	32	63.5	57.2	76.2	-	80	143	124	140	140		300	381	346	508
	25	63.5	50.8	76.2	-	65	143	121	140	140		250	381	333	508
	20	63.5	44.5	76.2	-	200	200	178	-	-		200	381	324	508
65	65	76.2	-	-	-	150	178	168	152	152	600	600	432	-	-
	50	76.2	69.9	88.9	-	125	178	162	152	152		500	432	432	508
	40	76.2	66.7	88.9	-	100	178	155	152	152		450	432	419	508
	32	76.2	63.5	88.9	-	80	178	152	152	152		400	432	406	508
	25	76.2	57.2	88.9	-	250	250	216	-	-		350	432	406	508
80	80	85.7	-	-	-	200	216	203	178	178		300	432	397	508
	65	85.7	82.6	88.9	-	150	216	194	178	178		250	432	384	508
	50	85.7	76.2	88.9	-	125	216	191	178	178	750	750	559	-	-
	40	85.7	73.0	88.9	-	100	216	184	178	178		600	559	533	610
	32	85.7	69.9	88.9	-	300	300	254	-	-		500	559	508	610
	25	85.7	69.9	88.9	-	250	254	241	203	203		450	559	495	610
90	90	95.3	-	-	-	200	254	229	203	203		400	559	483	610
	80	95.3	92.1	102	-	150	254	219	203	203	900	900	673	-	-
	65	95.3	88.9	102	-	100	254	210	203	203		750	673	635	610
	50	95.3	82.6	102	-	350	350	279	-	-		600	673	610	610
	40	95.3	79.4	102	-	300	279	270	330	330		500	673	584	610
					-	250	279	257	330	330		450	673	572	610
					-	200	279	248	330	330					
					-	150	279	238	330	330					

Reducing tees (b16.9)

Concentric & eccentric Reducers (b16.9)

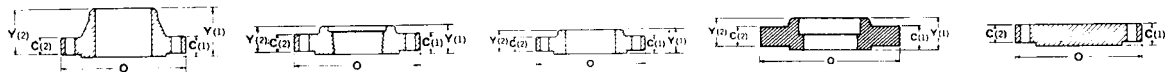
Flanges to American Standards

DN 15 to 600 are to ASME B16.5 (BS1560). DN 750 & 900 are to BS 3293 for Slip-On & Weldneck only.



Welding Neck Flange Threaded Flange Slip-On Flange Socket Welding (DN) 15-80 Blind Flanges up to DN600 (Above DN600 see notes below †)

Nom. Size Dn	PN20 (Class 150)						PN50 (Class 300)						PN100 (Class 600)						Nom. Size DN			
	Dia of Fig. 0	Thick-ness of Fig. Min. C(1)*	Length Thru Hub		Dia of Bolt Circle	Dia of Bolt Holes	No. of Bolts	Dia of Fig. 0	Thick-ness of Fig. Min. C(2)*	Length Thru Hub		Dia of Bolt Circle	Dia of Bolt Holes	No. of Bolts	Dia of Fig. 0	Thick-ness of Fig. Min. C(1)*	Length Thru Hub			Dia of Bolt Circle	Dia of Bolt Holes	No. of Bolts
15	90	11.5	16	48	60.5	16	4	95	14.5	22	52	66.5	16	4	95	14.5	22	52	66.5	16	4	15
20	100	13	16	52	70	16	4	120	16	25	57	82.5	20	4	120	16	25	57	82.5	20	4	20
25	110	14.5	17	56	79.5	16	4	125	17.5	27	62	89	20	4	125	17.5	27	62	89	20	4	25
32	120	16	21	57	89	16	4	135	19.5	27	65	98.5	20	4	135	21	29	67	98.5	20	4	32
40	130	17.5	22	62	98.5	16	4	155	21	30	68	114.5	22	4	155	22.5	32	70	114.5	22	4	40
50	150	19.5	25	64	120.5	20	4	165	22.5	33	70	127	20	8	165	26.5	37	73	127	20	8	50
65	180	22.5	29	70	139.5	20	4	190	25.5	38	76	149	22	8	190	29	41	79	149	22	8	65
80	190	24	30	70	152.5	20	4	210	29	43	79	168.5	22	8	210	32	46	83	168.5	22	8	80
90	215	24	32	71	178	20	8	230	30.5	44	81	184	22	8	230	35	49	86	184	26	8	90
100	230	24	33	76	190.5	20	8	255	32	48	86	200	22	8	275	38.5	54	102	216	26	8	100
125	255	24	36	89	216	22	8	280	35	51	98	235	22	8	330	44.5	60	114	267	30	8	125
150	280	25.5	40	89	241.5	22	8	320	37	52	98	270	22	12	355	48	67	117	292	30	12	150
200	345	29	44	102	298.5	22	8	380	41.5	62	111	330	26	12	420	55.5	76	133	349	33	12	200
250	405	30.5	49	102	362	26	12	445	48	67	117	387.5	30	16	510	63.5	86	152	432	36	16	250
300	485	32	56	114	432	26	12	520	51	73	130	451	33	16	560	66.5	92	156	489	36	20	300
350	535	35	57	127	476	30	12	585	54	76	143	514.5	33	20	605	70	94	165	527	39	20	350
400	600	37	64	127	540	30	16	650	57.5	83	146	571.5	36	20	685	76.5	106	178	603	42	20	400
450	635	40	68	140	578	33	16	710	60.5	89	159	628.5	36	24	745	83	117	184	654	45	20	450
500	700	43	73	145	635	33	20	775	63.5	95	162	686	36	24	815	89	127	190	724	45	24	500
600	815	48	83	152	749.5	36	20	915	70	106	168	813	42	24	940	102	140	203	838	52	24	600
750	985	54	89	130.2	914	35	28	1090	92	210	210	997	48	28	1130	114	248	248	1022	54	28	750
900	1170	60.3	95	136.5	1086	41	32	1270	105	241	241	1168	54	32	1315	124	283	283	1194	67	28	900

Nom. Size Dn	PN150 (Class 900)						PN250 (Class 1500)						PN420 (Class 2500)						Nom. Size DN			
	Dia of Fig. 0	Thick-ness of Fig. Min. C(2)†	Length Thru Hub		Dia of Bolt Circle	Dia of Bolt Holes	No. of Bolts	Dia of Fig. 0	Thick-ness of Fig. Min. C(2)†	Length Thru Hub		Dia of Bolt Circle	Dia of Bolt Holes	No. of Bolts	Dia of Fig. 0	Thick-ness of Fig. Min. C(2)†	Length Thru Hub			Dia of Bolt Circle	Dia of Bolt Holes	No. of Bolts
15							120	22.5	32	60	82.5	22	4	135	30.5	40	73	89	22	4	15	
20							130	25.5	35	70	89	22	4	140	32	43	79	95	22	4	20	
25							150	29	41	73	101.5	26	4	160	35	48	89	108	26	4	25	
32							160	29	41	73	111	26	4	185	38.5	52	95	130	30	4	32	
40							180	32	44	83	124	30	4	205	44.5	60	111	146	33	4	40	
50							215	38.5	57	102	165	26	8	235	51	70	127	171.5	30	8	50	
65							245	41.5	64	105	190.5	30	8	270	57.5	79	143	197	33	8	65	
80	240	38.5	54	102	190.50	26	8	270	48	73	118	203	33	8	305	67	92	168	228.5	36	8	80
100	295	44.5	70	114	235.00	32	8	310	54	90	124	241.5	36	8	355	76.5	108	190	273	42	8	100
125	350	51	79	127	279.50	35	8	375	73.5	105	155	292	42	8	420	92.5	130	229	324	48	8	125
150	380	56	86	140	317.50	32	12	395	83	119	171	317.5	39	12	485	108	152	273	368.5	56	8	150
200	470	63.5	102	162	393.5	39	12	485	92	143	213	393.5	45	12	550	127	178	318	438	56	12	200
250	545	70	108	184	470	39	16	585	108	159	254	482.5	52	12	675	165.5	229	419	539.5	68	12	250
300	610	79.5	117	200	533.5	39	20	675	124	181	283	571.5	56	16	760	184.5	254	464	619	76	12	300
350	640	86	130	213	559	42	20	750	133.5		298	635	60	16								350
400	705	89	133	216	616	45	20	825	146.5		311	705	68	16								400
450	785	102	152	229	686	52	20	915	162		327	774.5	76	16								450
500	855	108	159	248	749.5	54	20	985	178		356	832	80	16								500
600	1040	140	203	292	901.5	68	20	1170	203.5		406	990.5	94	16								600

Notes:

- * 1. The 2mm Raised Face is included in thickness C(1) and length through hub Y(1). This applies to PN20 and PN50 Pressure Ratings.
- † 2. The 7mm Raised Face is not included in thickness C(2) and length through hub Y(2). PN100, 150, 250 and 420 Pressure Ratings are regularly furnished with 7mm . Raised Face which is additional to the flange thickness C(2) and Y(2).
- 3. Always specify bore when ordering weldneck flanges. Bore dimensions shown opposite also provide inside pipe diameters.

Large Diameter Flanges Above DN 600

- For Blind Flanges refer to MSS SP44.
- BS 3293 covers Slip-On and Weldneck but excludes Blind Flanges.
- MSS SP44 covers Blind and Weldneck but excludes Slip-On Flanges.
- BS 3293 Weldneck PN20 flange thickness, C(1), is less than MSS SP44 equivalents.
- API - 605 Dimensions for Large Diameter Flanges vary considerably from both BS.
- 3293 and MSS SP44 — Details on request.

Raised Face Diam.	Nom. Size DN	O.D. of Pipe Mm	Approximate Welding Neck Flange Bores – mm																				
			All Press Ratings mm	Sch. 10	Sch. 20	Sch. 30	Std. Wt.	Sch. 40	Sch. 60	Ext. Stg.	Sch. 80	Sch. 100	Sch. 120	Sch. 140	Sch. 160	X.X Stg.							
35	15	21.3					15.8							13.9								11.8	6.4
43	20	26.7					20.9							18.9								15.5	11
51	25	33.4					26.6							24.3								20.7	15.2
65	32	42.2					35.1							32.5								29.5	22.8
73	40	48.3					40.9							38.1								34	27.9
92	50	60.3					52.5							49.2								42.9	38.2
105	65	73					62.7							59								54	45
127	80	88.9					77.9							73.7								66.7	58.4
140	90	101.6					90.1							85.4								-	-
157	100	114.3					102.3							97.2								87.3	80.1
186	125	141.3					128.2							122.3								115.9	109.6
216	150	168.3					154.1							146.3								139.7	131.8
270	200	219.1					202.7							198.5								188.9	182.6
324	250	273.1					254.5							247.7								236.5	230.2
381	300	323.9					304.8							295.3								288.9	281
413	350	355.6	342.9	339.8	336.6	336.6	333.3	325.4	330.2	295.3	298.5	288.9	281	273.1	266.7	257.2	273.1	266.7	257.2	273.1	266.7	257.2	273.1
470	400	406.4	393.7	390.6	387.4	387.4	381	373.1	381	363.5	354	344.5	333.3	325.4									
533	450	457	444.5	441.4	434.9	438.2	428.7	419.1	431.8	409.5	398.5	387.4	377.9	366.7									
584	500	508	495.3	489	482.6	489	477.8	466.8	482.6	455.6	442.9	431.8	419.1	408									
692	600	610	596.9	590.6	581.1	590.6	574.6	560.4	584.2	547.7	531.8	517.6	504.9	490.5									
857	750	762	746.2	736.6	730.2	743			736.6														
1022	900	914	898.6	889	882.6	895.4	876.3		889														

All dimensions are shown in millimetres - mm

Bolting for ANSI Flanges

Bolting

To suit R.F. Flange sizes DN 15 to 600 to ASME- B16.5 (BS. 1560) and DN 750 & 900 to BS. 3293

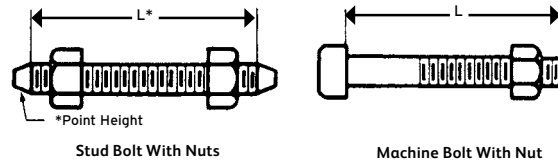

Nom. Flge Size Dn	PN 20 (Class 150)				PN 50 (Class 300)				PN 100 (Class 600)			PN 150 (Class 900)			PN 250 (Class 1500)			PN 420 (Class 2500)			Nom. Flge Size Dn	
	No. Bolts	Dia. Bolts ins.	Stud Bolts mm	Mach Bolts mm	No. Bolts	Dia. Bolts ins.	Stud Bolts mm	Mach Bolts mm	No. Bolts	Dia. Bolts ins.	Stud Bolts mm	No. Bolts	Dia. Bolts ins.	Stud Bolts mm	No. Bolts	Dia. Bolts ins.	Stud Bolts mm	No. Bolts	Dia. Bolts ins.	Stud Bolts mm		
15	4	1/2	60	45	4	1/2	65	55	4	1/2	80	Use PN250 Dimensions in these sizes			4	3/4	105	4	3/4	125	15	
20	4	1/2	65	50	4	5/8	75	60	4	5/8	90				4	3/4	115	4	3/4	125	20	
25	4	1/2	65	55	4	5/8	80	65	4	5/8	90				4	7/8	125	4	7/8	140	25	
32	4	1/2	70	55	4	5/8	80	65	4	5/8	100				4	7/8	125	4	1	150	32	
40	4	1/2	70	60	4	3/4	90	75	4	3/4	105				4	1	140	4	1 1/8	170	40	
50	4	5/8	80	65	8	5/8	90	75	8	5/8	105				8	7/8	145	8	1	175	50	
65	4	5/8	90	75	8	3/4	100	85	8	3/4	120				8	1	160	8	1 1/8	195	65	
80	4	5/8	90	75	8	3/4	110	90	8	3/4	125				8	7/8	145	8	1 1/4	220	80	
90	8	5/8	90	75	8	3/4	110	95	8	7/8	140				-	-	-	-	-	-	-	90
100	8	5/8	90	75	8	3/4	110	95	8	7/8	145				8	1 1/8	170	8	1 1/4	195	8	1 1/2
125	8	3/4	90	80	8	3/4	120	100	8	1	165	8	1 1/4	190	8	1 1/2	250	8	1 3/4	300	125	
150	8	3/4	100	85	12	3/4	125	105	12	1	170	12	1 1/8	195	12	1 3/8	260	8	2	345	150	
200	8	3/4	110	90	12	7/8	140	110	12	1 1/8	195	12	1 3/8	220	12	1 5/8	290	12	2	380	200	
250	12	7/8	115	95	16	1	155	130	16	1 1/4	215	16	1 3/8	235	12	1 7/8	335	12	2 1/2	485	250	
300	12	7/8	120	100	16	1 1/8	170	145	20	1 1/4	220	20	1 3/8	255	16	2	375	12	2 3/4	540	300	
350	12	1	130	110	20	1 1/8	175	150	20	1 3/8	235	20	1 1/2	275	16	2 1/4	405				350	
400	16	1	135	115	20	1 1/4	190	160	20	1 1/2	255	20	1 5/8	285	16	2 1/2	445				400	
450	16	1 1/8	150	125	24	1 1/4	195	170	20	1 5/8	275	20	1 7/8	325	16	2 3/4	495				450	
500	20	1 1/8	160	135	24	1 1/4	205	180	24	1 5/8	290	20	2	345	16	3	540				500	
600	20	1 1/4	175	145	24	1 1/2	230	195	24	1 7/8	330	20	2 1/2	435	16	3 1/2	615				600	
750	28	1 1/4	190	160	28	1 3/4	290	250	28	2	355	PN150, 250 & 420 – Not Listed in BS 3293						750				
900	32	1 1/2	215	180	32	2	325	280	28	2 1/2	400										900	

Raised Face height of 2 mm for PN20 & 50 and 7 mm for PN100, 150, 250 & 420 is included in dimension L (Bolt Length)

Material Specifications

ASTM A193 Grade B7 Standard specification for alloy steel and stainless steel bolting materials for high temperature service.

ASTM A194 Grade 2h Standard specification for carbon and alloy steel nuts for bolts for high pressure and high temperature service.

ASTM A320 Standard specification for alloy steel bolting materials for low temperature service. Grade L7 covers alloy steel stud bolts. Grade L4 covers alloy steel nuts to suit Grade L7 stud bolts.

Inch / Metric Bolting interchangeable for ASME B16.5 flanges as below	
For	Use
1/2	M14
5/8	M16
3/4	M20
7/8	M24
1	M27
1 1/8	M30
1 1/4	M33
1 3/8	M36
1 1/2	M39
1 5/8	M42
1 3/4	M45
1 7/8	M48
2	M52
2 1/4	M56
2 1/2	M64
2 3/4	M72

Buttweld Fittings and Flanges to ASME Standards

ASME B36.10 Steel Pipe Dimensions					Approximate Mass of Popular Sizes												
Nom. Pipe Size DN	Outside Diam. mm	Inside Diam. mm	Identification		Pipe	Buttweld Fittings			A.S.M.E Flanges								
			Std. X.S	Sch. No.	Steel Pipe	90o L/R Elbows	Tees Equal	Con. & Ecc. Red	PN20 (150)			PN50 (300)			PN100 (600)	PN150 (900)	
					kg/m	kg/ea	kg/ea	kg/ea	SOW/ SW Thrded kg/ea	W/N kg/ea	Blind kg/ea	SOW/ SW Thrded kg/ea	W/N kg/ea	Blind kg/ea	W/N kg/ea	W/N kg/ea	
15	21.3	15.8 13.9	Std. XS	40 80	1.27 1.62	0.08 1.62	0.16 0.21	– –	0.45	0.79	0.57	0.73	0.91	0.79	0.91	2	
20	26.7	20.9 18.9	Std. XS	40 80	1.69 2.20	0.08 0.11	0.21 0.27	0.07 0.10	0.68	0.86	0.91	1.25	1.41	1.13	1.59	2.72	
25	33.4	26.6 24.3	Std. XS	40 80	2.50 3.24	0.17 0.21	0.34 0.43	0.14 0.18	0.95	1.09	1.09	1.36	1.81	1.77	1.86	3.86	
32	42.2	35.1 32.5	Std. XS	40 80	3.39 4.47	0.28 0.39	0.64 0.75	0.18 0.23	1.13	1.41	1.25	2.04	2.27	2.68	2.72	4.54	
40	48.3	40.9 38.1	Std. XS	40 80	4.05 5.41	0.39 0.50	0.95 1.13	0.27 0.32	1.36	1.81	1.7	2.81	3.06	2.83	3.74	6.35	
50	60.3	52.5 49.2	Std. XS	40 80	5.44 7.48	0.68 1.00	1.45 1.72	0.41 0.54	2.22	2.83	2.77	3.13	3.74	3.52	4.65	10.89	
65	73	62.7 59.0	Std. XS	40 80	8.63 11.41	1.39 1.82	2.45 2.95	0.68 0.91	3.82	4.42	4.04	4.54	5.56	5.44	6.44	16.33	
80	88.9	77.9 73.7	Std. XS	40 80	11.29 15.27	2.18 2.86	3.45 4.30	0.91 1.27	4.08	5.22	5.44	6.12	7.37	7.26	8.5	14.51	
90	101.6	90.1 85.4	Std. XS	40 80	13.57 18.63	3.05 4.1	4.5 5.9	1.36 1.81	4.99	5.44	6.35	7.71	9.53	9.98	12.25	–	
100	114.3	102.3 97.2	Std. XS	40 80	16.07 22.32	4.2 5.7	5.7 7.3	1.59 2.18	5.94	7.48	7.37	9.53	11.79	11.79	17.24	23.23	
125	141.3	128.2 122.3	Std. XS	40 80	21.77 30.97	6.8 10.0	9.1 11.8	2.7 3.8	6.12	9.53	9.07	12.7	15.42	15.88	30.84	39.01	
150	168.3	154.1 146.3	Std. XS	40 80	28.26 42.56	10.9 16.3	13.6 19.0	3.9 5.4	8.16	11.34	12.7	16.3	19.96	20.87	34.02	49.9	
200	219.1	202.7 193.7	Std. XS	40 80	42.55 64.64	21.8 33.1	25 33.5	5.9 8.6	12.7	19.05	21.77	25.4	32.21	38.1	52.16	84.82	
250	273.1	254.5 247.7	Std. XS	40 60	60.31 81.55	38.6 52	41 54	10 14	17.24	25.4	31.75	35.38	44	53.34	90.36	121.56	
300	323.9	304.8 298.5	Std. XS	– –	73.88 97.46	57 75	57 77	15 20	27.22	38.1	45.36	50.8	64.41	86.18	101.6	168.74	
350	355.6	336.6 330.2	Std. XS	30 –	81.33 107.39	73 97	73 93	28 37	35.38	51.26	58.97	74.39	84.37	107.05	157.4	254.92	
400	406.4	387.4 381.0	Std. XS	30 40	93.27 123.30	98 130	91 120	35 46	42.48	63.5	77.11	101.6	111.58	145.15	209.11	310.71	
450	457	438.2 431.8	Std. XS	– –	105.16 139.15	120 165	135 190	40 53	52.62	68.04	102.51	126.1	138.35	181.89	217.27	419.12	
500	508	489.0 482.6	Std. XS	20 30	117.15 155.12	150 200	168 245	61 82	65.32	81.65	123.38	149.69	174.63	231.33	312.98	527.98	
600	610	590.6 584.2	Std. XS	20 –	141.12 187.26	220 280	240 350	77 95	91.63	118.84	203.21	222.23	247.21	342.92	443.16	680.39	

Note: InfraBuild Steel Centre reserve the right to change specifications without notice. Not all products are available at all InfraBuild Steel Centre branches. InfraBuild Steel Centre also has access to a wide network of products not necessarily listed in this book. Please check with your local InfraBuild Steel Centre branch for product availability.

I.S.O. Metric Hexagon Steel Bolts

(For use with AS.2129 Flanges)

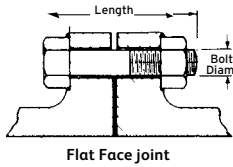

Steel hexagon Bolts and Nuts (XOX) are recommended for use within a temperature range of -50°C to +300°C. Outside of this temperature range, Stud Bolts should be used as recommended in AS.2528.

A quick reference chart for sizing bolts and nuts for a range of regularly used standard flanges is given below:

APPLICABLE TO PLATE & FORGED STEEL LOOSE FLANGES ONLY

Integral valve flanges quite often differ in thickness to equivalent loose flanges. When integral flanges are involved due allowance should be made to bolt lengths.

Bolt lengths listed apply to flat-faced or 1.6mm raised face flanges with allowance for 1.6mm gasket thickness.

*For approximate Stud Bolt Lengths take the XOX Bolt Length and add the metric diameter in mm rounded to the nearest 5mm increment up

Note: (This does not include length of point)

This chart shows bolt diameters as recommended in AS.2129. Some of these are Non-preferred sizes e.g. (M27), (M33) and (M39) which are not readily available in Australia.

Stud Bolts should be used as alternatives to bolts where the size is greater than M24 and it is therefore suggested that Stud Bolts as specified in AS.2528 or BS.4882 should be used.

Inch series bolts interchangeable as follows:

For	Use	For	Use
1/4"	M6	7/8"	M24
5/16"	M8	1"	(M27)
3/8"	M10	1 1/8"	M30
1/2"	M12	1 1/4"	(M33)
5/8"	M16	1 3/8"	M36
3/4"	M20	1 1/2"	(M39)

Nominal Flange Size DN	Table D		Table E		Table F		Table H	
	No. Bolts Per Flange	XOX Bolt & Nut Dia. x lgth	No. Bolts Per Flange	XOX Bolt & Nut Dia. x lgth	No. Bolts Per Flange	XOX Bolt & Nut Dia. x lgth	No. Bolts Per Flange	XOX Bolt & Nut Dia. x lgth
15	4	M12 x 40mm*	4	M12 x 40mm*	4	M12 x 40mm*	4	M16 x 45mm*
20	4	M12 x 40mm*	4	M12 x 40mm*	4	M12 x 40mm*	4	M16 x 45mm*
25	4	M12 x 40mm*	4	M12 x 40mm*	4	M12 x 40mm*	4	M16 x 50mm*
32	4	M12 x 40mm*	4	M12 x 40mm*	4	M16 x 45mm*	4	M16 x 55mm*
40	4	M12 x 40mm*	4	M12 x 40mm*	4	M16 x 45mm*	4	M16 x 55mm*
50	4	M16 x 45mm*	4	M16 x 45mm*	4	M16 x 50mm*	4	M16 x 60mm*
65	4	M16 x 45mm*	4	M16 x 45mm*	8	M16 x 50mm*	8	M16 x 60mm*
80	4	M16 x 45mm*	4	M16 x 45mm*	8	M16 x 50mm*	8	M16 x 65mm*
100	4	M16 x 45mm*	8	M16 x 45mm*	8	M16 x 60mm*	8	M16 x 70mm*
125	8	M16 x 45mm*	8	M16 x 50mm*	8	M20 x 70mm*	8	M20 x 80mm*
150	8	M16 x 45mm*	8	M20 x 60mm*	12	M20 x 70mm*	12	M20 x 80mm*
200	8	M16 x 45mm*	8	M20 x 60mm*	12	M20 x 75mm*	12	M20 x 90mm*
250	8	M20 x 55mm*	12	M20 x 70mm*	12	M24 x 85mm*	12	M24 x 100mm*
300	12	M20 x 60mm*	12	M24 x 80mm*	16	M24 x 100mm*	16	M24 x 110mm*
350	12	M24 x 75mm*	12	M24 x 85mm*	16	M27 x 100mm*	16	M27 x 130mm*
400	12	M24 x 75mm*	12	M24 x 100mm*	20	M27 x 120mm*	20	M27 x 140mm*
450	12	M24 x 80mm*	161	M24 x 100mm*	20	M30 x 130mm*	20	M30 x 160mm*
500	16	M24 x 85mm*	16	M24 x 110mm*	24	M30 x 140mm*	24	M30 x 170mm*
600	16	M27 x 100mm*	16	M30 x 130mm*	24	M33 x 150mm*	24	M30 x 190mm*
700	20	M27 x 100mm*	20	M30 x 140mm*	24	M33 x 160mm*		
750	20	M30 x 120mm*	20	M33 x 150mm*	28	M33 x 170mm*		
800	20	M33 x 120mm*	20	M33 x 150mm*	28	M33 x 180mm*		
900	24	M33 x 140mm*	24	M33 x 170mm*	32	M36 x 200mm*		
1000	24	M33 x 140mm*	24	M36 x 180mm*	36	M36 x 220mm*		
1200	32	M33 x 160mm*	32	M36 x 200mm*	40	M39 x 240mm*		

Notes:

- All dimensions are in millimetres (mm).
- High strength structural bolts to AS 1252 may be substituted for property class 8.8 bolts if agreed to by the purchaser.
- Bolts to AS 1252 are heavy hexagon series and the selection of such bolts would be subject to space being available on the relevant flange.

Bolt Hole Diameters

For bolts to M24, clearance hole 2mm larger. Above M24, clearance hole 3mm larger.

XOX Bolts & Nuts

XOX is the trade term used for H.R.H. commercial steel bolts and nuts.

H.R.H. denotes Hexagon Head x Round Shank x Hexagon Nut.

XOX Bolting		
Temp. Range: -50°C to +300°C		
Flange Specifications		
Table	Bolts	Nuts
D, E, F	AS 1110 Gr.4.6 or AS 1111 Gr.4.6	AS 1112 Gr.5
H	AS 1110 Gr.8.8	AS 1112 Gr.8

Fabricated Fencing

Description	Size (cm)	Finish	Length (m)	Weight (kg/roll)	Pack Size (rolls)
Ringlock® Heavy Galvanised Strongline (2.8mm Wire Top & Bottom)	6-70-30	Heavy Galvanised	200	78.0	9
	6-90-30		200	83.0	9
	7-90-30		200	93.0	9
Ringlock® Standard Galvanised	5-70-30	Galvanised	200	61.0	9
	5-70-90		500	114.0	5
	6-70-30		200	71.0	9
	6-90-30		200	73.0	9
	7-90-30		200	86.0	9
	7-90-60		200	69.0	9
	8-90-15		100	65.0	9
	8-90-30		200	95.0	9
	Hinge Joint Standard Galvanised (2.5mm Wire)		6-70-30	Galvanised	200
6-90-30		200	73.0		9
7-90-30		200	86.0		9
8-80-15		100	60.0		9
8-90-30		200	95.0		9
8-90-15		100	65.0		9
Zedlock® Heavy Galvanised Strongline (2.8mm Wire Top & Bottom)	6-70-30	Heavy Galvanised	200	76.0	9
	6-90-30		200	78.4	9
	7-90-30		200	88.0	9
	7-90-30		500	218.0	4
	7-90-45		500	193.5	MTO
	8-90-30		200	97.5	9
	13-90-15		100	86.7	MTO
Zedlock® Heavy Galvanised	15-150-15	100	111.2	MTO	
	6-70-30	Heavy Galvanised	200	71.5	9
	6-70-45		200	65.0	9
	7-90-30		200	84.0	9
	7-90-30		500	218.0	4
	7-90-45		200	75.0	MTO
	8-90-15		100	63.0	9
	8-90-30		200	93.6	9
8-115-15	100		67.0	9	
Zedlock® Economy Standard Galvanised (2.0mm Wire)	8-90-15	Galvanised	50	20.5	16
	8-90-15		100	41.0	9
	8-115-15		50	22.5	16
	8-115-15		100	45.0	9
Zedlock® Dog Fence - Standard Galvanised (2.0mm Wire)	12-120-15	Galvanised	50	29.0	MTO
	12-120-15		100	57.0	MTO

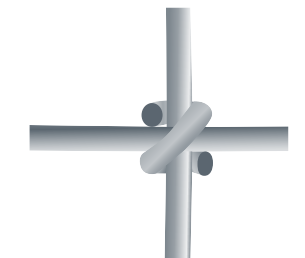
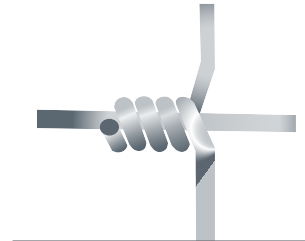
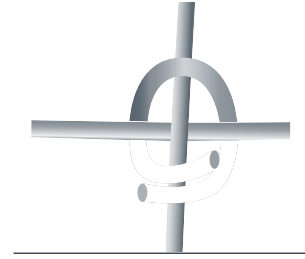

Fence Wire

Description	Size (cm)	Finish	Length (m)	Weight (kg/roll)	Pack Size (rolls)
Plain Wire Heavy Galvanised	2.50	Heavy Galvanised - Supa-Ten High Tensile	1500	58	10
	2.50	Heavy Galvanised - Flexi-Ten Medium Tensile	1500	58	10
Plain Wire Standard Galvanised	2.80	Galvanised - Supa-Ten High Tensile	1000	48	10
	2.50	Galvanised - Supa-Ten High Tensile	1500	58	10
	2.50	Galvanised - Flexi-Ten Medium Tensile	1500	58	10
	4.00	Galvanised - Soft-Ten Soft Tensile	500	49	10
	3.15	Galvanised - Soft-Ten Soft Tensile	750	46	10
Plain Wire Handy Pack Standard Galvanised	2.50	Galvanised - Flexi-Ten Medium Tensile	250	10	10
	3.15	Galvanised - Soft-Ten Soft Tensile	250	16	10
Plain Wire Standard Galvanised Red Tag	2.50	Galvanised - High Tensile Red Tag	1500	58	MTO
	2.50	Galvanised - Medium Tensile Red Tag	1500	58	MTO
Tie Wire Heavy Galvanised Soft	1.60		3200	50	MTO
	2.00	Galvanised - Soft	2000	50	MTO
	2.50		1300	50	10



Trellis Wire

Description	Size (cm)	Finish	Length (m)	Weight (kg/roll)	Pack Size (rolls)
Trellis Wire Heavy Galvanised	2.00	High Tensile	2000	50	10
	2.65		1000	43	10
	2.85		1000	50	10
	3.15		1000	61	10



Cyclone®

Tie Wire

Item Category	Diameter (mm)	Finish	Length (m)	Weight (kg/roll)	Pack Size (rolls)
Tie Wire	0.7	Standard Galvanised	75	0.5	20
	0.90		75	0.5	20
	1.25		50	0.5	20
	1.57		30	0.5	20
	2.00		20	0.5	20
	1.25	Standard Galvanised (1kg)	100	1	12
	1.57		67	1	12
	2.00		40	1	12
	1.25	Standard Galvanised (3kg)	300	3	6
	1.57		200	3	6
	2.00		120	3	6
	2.50		80	3	6

Barbed Wire

Description	Size (cm)	Finish	Length (m)	Weight (kg/roll)	Pack Size (rolls)
IOWA Barbed Wire - Low Tensile	2.50 mm	Galvanised	400	41.0	18
Barbed Wire - High Tensile	1.57 mm	Heavy Galvanised	500	22.0	36
	1.80 mm	Heavy Galvanised	500	27.0	36
Barbed Wire - High Tensile - Handy Pack	1.57 mm	Galvanised	30	1.9	3
			100	7.0	3



Netting

Animal

Description	Height (cm)	Aperture (cm)	Wire Diameter (mm)	Finish	Length (m)	Pack Size (rolls)	Weight (kg/roll)
Aviary Netting	90	1.27	2.5 x 1.24	Standard Galvanised	30	5	28
	120	1.27	2.5 x 1.24		30	5	37
Cage Mesh	90		2.5 x 1.24	Standard Galvanised	30	5	18
Dog & Boundary Netting	120	graduated	2.0	Standard Galvanised	30	5	15
Bird and Vermin Netting	90	1.3	0.56	Standard Galvanised	50	5	13.7
	120	1.3	0.56		50	5	20.0
	180	1.3	0.56		50	5	29.0
Animal Netting	90	3	0.90	Standard Galvanised	50	5	20.5
	120	3	0.90		50	5	27.0
	180	3	0.90		50	5	40.0
Chicken Netting	90	5	1.00	Standard Galvanised	50	5	12.6
	120	5	1.00		50	5	17.5
	180	5	1.00		50	5	26.0



Hexagonal

Description	Height (cm)	Aperture (cm)	Wire Diameter (mm)	Finish	Length (m)	Pack Size (rolls)	Weight (kg/roll)
Hexagonal Netting - Heavy Galvanised	180	4	1.4	Heavy Galvanised	50	7	73.0
	120	4	1.4		50	7	49.0
	105	4	1.4		50	16	44.0
	105	4	1.4		100	9	87.0
	90	4	1.4		50	16	38.0
	90	4	1.4		100	9	75.0
	60	4	1.4		50	7	26.0
	30	4	1.4		100	18	28.0



Cyclone®

Posts

Item Category	Finish	Length (cm)	Weight (kg)
Steely Posts	Hot-Dipped Galvanised	150	2.85
	Hot-Dipped Galvanised	165	3.2
	Hot-Dipped Galvanised	210	4.1
	Hot-Dipped Galvanised	240	4.7
Steely Posts Black Bituminous Coating	Black Bituminous	135	2.6
	Black Bituminous	150	2.8
	Black Bituminous	165	3.1
	Black Bituminous	180	3.4
	Black Bituminous	210	4
	Black Bituminous	240	4.6
"XL" Steely Posts	Black Bituminous	180	5.2
Steely Posts –Black Bituminous coating Loose Utility Pack	Black Bituminous	165	2.9
	Black Bituminous	180	3.2
Economy Fence Post (Rail) Black Bituminous Coating	Black Bituminous	45	0.7
	Black Bituminous	60	0.9
	Black Bituminous	90	1.4
	Black Bituminous	135	2.1
	Black Bituminous	150	2.3
	Black Bituminous	165	2.6
	Black Bituminous	180	2.8
	Black Bituminous	240	3.8
Economy Fence Post	Hot-Dipped Galvanised	135	2.24
	Hot-Dipped Galvanised	165	2.74
	Hot-Dipped Galvanised	180	2.99
	Hot-Dipped Galvanised	240	3.98



Safety Yellow Post Caps

- Can be used with Cyclone economy posts, Cyclone traditional posts and Cyclone Livestock posts
- Fits most Y posts
- Bright yellow for visibility and safety



Gates



Description	Finish	Height (mm)	Width	Pack Size (gates)	Weight (kg)
N-SURE Gate	Hot-Dipped Galvanised	1170	2370 mm (8 FT)	7	25
	Hot-Dipped Galvanised	1170	2670 mm (9 FT)	7	27
	Hot-Dipped Galvanised	1170	2970 mm (10 FT)	7	30
	Hot-Dipped Galvanised	1170	3270 mm (11 FT)	7	32
	Hot-Dipped Galvanised	1170	3570 mm (12 FT)	7	34
	Hot-Dipped Galvanised	1170	3870 mm (13 FT)	7	37
	Hot-Dipped Galvanised	1170	4170 mm (14 FT)	7	39
	Hot-Dipped Galvanised	1170	4470 mm (15 FT)	7	42
	Hot-Dipped Galvanised	1170	4770 mm (16 FT)	7	43
	Hot-Dipped Galvanised	1170	5370 mm (18 FT)	7	48
	Hot-Dipped Galvanised	1170	6070 mm (20 FT)	7	54
	Hot-Dipped Galvanised	1500	3750 mm (12 FT)	7	38
	Hot-Dipped Galvanised	1500	4170 mm (14 FT)	7	43
Access Gate	Hot-Dipped Galvanised	1800	3570 mm (12 FT)	7	44
	Hot-Dipped Galvanised	1800	4170 mm (14 FT)	7	49
Vertical Brace Gate	Hot-Dipped Galvanised	1170	1000 mm (3 FT)	7	9
	Hot-Dipped Galvanised	1170	1170 mm (4 FT)	7	12
	Hot-Dipped Galvanised	1170	1470 mm (5 FT)	7	15
	Hot-Dipped Galvanised	1170	1770 mm (6 FT)	7	17
	Hot-Dipped Galvanised	1170	2370 mm (8 FT)	7	21
	Hot-Dipped Galvanised	1170	2970 mm (10 FT)	7	25
	Hot-Dipped Galvanised	1170	3570 mm (12 FT)	7	29
	Hot-Dipped Galvanised	1170	4170 mm (14 FT)	7	34
Galvanised 5 Bar Gate	Hot-Dipped Galvanised	1170	4770 mm (16 FT)	7	39
	Hot-Dipped Galvanised	1170	2370 mm (8 FT)	7	25
	Hot-Dipped Galvanised	1170	2970 mm (10 FT)	7	30
	Hot-Dipped Galvanised	1170	3570 mm (12 FT)	7	34
	Hot-Dipped Galvanised	1170	4170 mm (14 FT)	7	41
	Hot-Dipped Galvanised	1170	4770 mm (16 FT) Mesh Infill	7	46

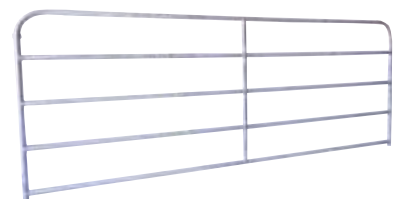
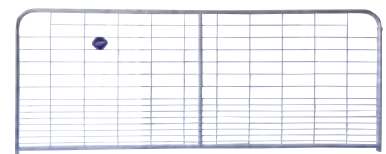
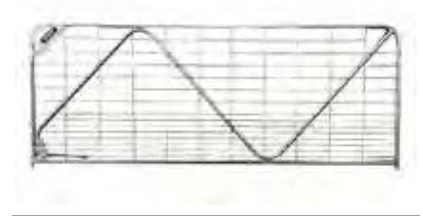

Universal Fence Fitting System

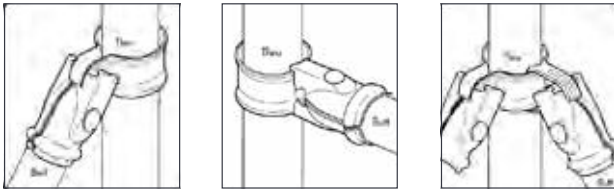
Downee®

Rail Clamp

Post Clamp

Multi Purpose Connector

Description	Finish	Size mm
Rail Clamps	Galvanized	25, 32, 40, 50
Post Clamps	Galvanized	25, 32, 40, 50, 65, 80, 100
Multi Purpose Connector	Galvanized	

Note: All rail and post clamps are interchangeable with each other.

Hinges & Gudgeons

Downee®



Long Plate Gudgeons

Two Part Hinges

Pipe Hinge Strap

Description	Finish	Size mm
Long Plate Gudgeons	Galvanized	20NB, 25NB
Two Part Hinges	Galvanized	Post - 50NB, 80NB Gate - 25NB
Pipe Hinge Strap	Galvanized	25NV

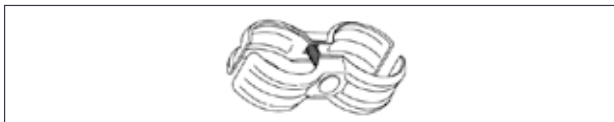
Temporary Fence Clamps

Downee®

Fit Pipe Size mm
32 x 32, 40 x 40, 50 x 50

Hinges & Gudgeons

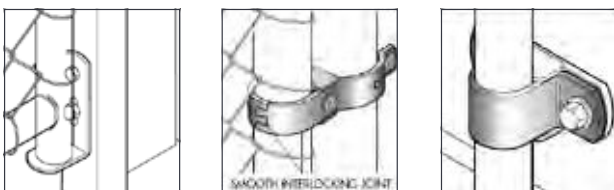

Downee®

FGP3

FGP15

Socket & Pin

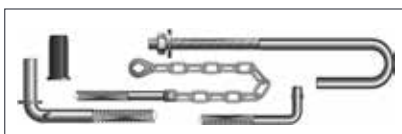

FGP1

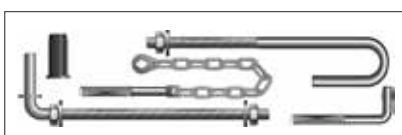

FGP4

Description
FGP1 – Ring Chain Catches, Screw In with gudgeons and clamps (Galvanized)
FGP3 – Ring Chain Catches, Screw In with gudgeons and clamps (Galvanized)
FGP4 – Ring Chain Catches, Screw In with gudgeons and clamps (Galvanized)
FGP15 – Ring Chain Catches, Screw In with gudgeons and clamps (Galvanized)
Socket & Pin

Note: InfraBuild Steel Centre reserve the right to change specifications without notice. Not all products are available at all InfraBuild Steel Centre branches. InfraBuild Steel Centre also has access to a wide network of products not necessarily listed in this book. Please check with your local InfraBuild Steel Centre branch for product availability.



We are the machines and equipment which cultivate and house Australia's food source.

InfraBuild Steel Centre can provide a total steel solution to simplify your farm steel and fencing needs from start to finish. We also supply steel to the many manufacturers who make the equipment which our farmers use.



Shed Tek[®]

14 x 22 – Fine thread. 14g screws with 5/16" head size to eliminate driver changes, generally used in shed construction with plates and cleats.

14 x 25 – Coarse thread. 14g screws with 5/16" head size to eliminate driver changes, generally used in shed construction with plates and cleats.



AutoTek[®]

M5.5 x 39 – Fixing corrugated roof sheet to steel purlins 1.9mm to 3.5mm.

M5.5 x 50 – Fixing square rib roof sheet to steel purlins 1.9mm to 3.5mm.



Rippletex

10 x 20 – Fixing mini corrugated and corrugated sheets to steel.

10 x 30 – Fixing mini corrugated and corrugated sheets to timber.



Series 500 SuperTEKS[®]

12 x 32 – Wafer head for flush fit needs such as walkways. Drills 3mm to 12.5mm hot rolled steel.

12 x 32, 12 x 50, 12 x 65 – Hex head with or without seal. Drills 3mm to 12.5mm hot rolled steel for roof and wall cladding, pipe and cable saddles, metal deck clips, brackets, signage and plumbing applications.



RoofZips[®]

M6 x 25 – Fixing wall cladding, stitching & general fastening into both timber & steel up to 1.5mm.

M6 x 50 – Fixing corrugated roof sheet to timber, metal batten & steel purlin up to 1.5mm. Also suits square profile sheet fixed to metal battens & steel purlins up to 1.5mm.

M6 x 25 – Fixing wall cladding, stitching & general fastening into both timber & steel up to 1.5mm.



Hi-Teks[®] – General Purpose Fasteners

10 x 16 – Used in fencing, steel house frames, DuraGal[®] flooring systems, shed and wall cladding with seal.

12 x 20 – Used in fencing, steel house frames, sheds and wall cladding with seal.

14 x 22 – Used in DuraGal[®] flooring systems, sheds and heavier assembly.



BattenZips[®]

M5.5 x 40 – Fixing metal roof battens to either timber or steel rafters.



PolyZips[®]

M6.5 x 50 – Fixing corrugated polycarbonate sheet to timber, metal batten and steel purlin up to 1.5mm, also suits square profile fixed to metal battens and steel purlins up to 1.5mm.

M6.5 x 65 – Fixing square profile polycarbonate sheet to timber battens.



Wingteks[®]

6 x 50, 8 x 32, 10 x 40, 10 x 45, 10 x 55, 10 x 75, 14 x 65 – Countersunk ribbed head for applications where timber is fastened to steel, gates, fences, decking but not recommended for treated timber decks to steel.



Bugle Batten

14 x 50, 14 x 75, 14 x 100 – Countersunk head for fixing timber battens to rafters, fastening heavy timbers, fencing, boardwalks, pergolas, plates and hinges to timber.



Fibreglass Tek[®]

M6.5 x 65, M6.5 x 85 – 32mm weatherlok fixing fibreglass sheet to steel up to 3mm, drills the expansion hole during installation.

Geometry and Mensuration

Shape	Area or Volume	Formulae	Results – Area or Volume
Rectangles	Area	Multiply length by width	$A (m) \times B (m) = \text{Square metres}$
Squares	Area	Multiply length by width	$A (m) \times B (m) = \text{Square metres}$
Cubes	Volume	Length x Width x Height	$A (m) \times B (m) \times H (m) = \text{Cubic metres}$
Circles	Circumference	Multiply diameter by Pi (or 3.142858)	$D (m) \times \text{Pi} = \text{metres}$
Circles	Area	$\text{Pi} \times \text{Radius} \times \text{Radius}$ [or R^2]	$(R^2) \times \text{Pi} = \text{Square metres}$
Sector of a circle	Area	Length of Arc x Half Radius	$A (m) \times R/2 = \text{Square metres}$
Triangles	Area	Base/2 x Height	$B/2 (m) \times H = \text{Square metres}$
Ellipse	Area	Long axis x Short axis x 0.7854	$D1 (m) \times D2 (m) \times 0.7854 = \text{Square metres}$
Ellipse	Volume	Long axis x Short axis x 0.7854 x Length	$D1 (m) \times D2 (m) \times 0.7854 = \text{Square metres}$
Cylinder	Area	Circumference of base x Height	$D (m) \times \text{Pi} \times H (m) = \text{Square metres}$
Cylinder	Volume	Area of base x Height	$(R^2) \times \text{Pi} \times H (m) = \text{Cubic metres}$
Sphere	Area	Diameter x Diameter x Pi	$D (m) \times D (m) \times \text{Pi} = \text{Cubic metres}$
Sphere	Volume	Diameter x Diameter x Diameter x 0.5236	$D (m) \times D (m) \times D (m) \times 0.5236 = \text{Cubic metres}$
Pyramid	Area	Perimeter of base x Slant Height/3	$[A (m) + B (m) \times 2 \times \text{Slant height}]/3 = \text{Square metres}$
Pyramid	Volume	Area of base x Vertical Height/3	$[A (m) + B (m) \times H (m)]/3 = \text{Cubic metres}$

Gauge Conversions

Conversion Factors

mm	Gauge	Imperial	
		Decimal	Inch
0.40	26		
0.60	24		
0.80	22	0.032	1/32
1.00	20		
1.20	18	0.047	3/64
1.40	17	0.055	
1.60	16	0.063	1/16
1.80	15	0.071	
2.00	14	0.080	5/64
2.30	13	0.092	3/32
2.50	12	0.098	
2.80	11	0.110	
3.00	10	1.125	1/8
3.50	9	0.138	
4.00	8	0.160	5/32
5.00	6	0.197	3/16
6.00	4	0.236	
6.30	3	0.250	1/4
8.00	2	0.315	5/16
9.00	1	0.354	
10.00	0	0.394	3/8
12.70		0.500	1/2
16.00		0.625	5/8
19.00		0.750	3/4
22.00		0.875	7/8
25.40		1.000	1

Note: InfraBuild Steel Centre reserve the right to change specifications without notice. Not all products are available at all InfraBuild Steel Centre branches. InfraBuild Steel Centre also has access to a wide network of products not necessarily listed in this book. Please check with your local InfraBuild Steel Centre branch for product availability.

Conversion Tables

Mass Conversions kilos/pounds			
Kilogram kg	Pound lb	Pound lb	Kilogram kg
1	2.205	1	0.4536
2	4.409	2	0.9072
3	6.614	3	1.361
4	8.818	4	1.814
5	11.02	5	2.268
6	13.23	6	2.722
7	15.43	7	3.175
8	17.64	8	3.629
9	19.84	9	4.082
10	22.05	10	4.536
50	110.2	50	22.68
100	220.5	10	45.36

Mass Conversions tonnes/tons			
Tonnes	Tons	Tons	Tonnes
1	0.9842	1	1.016
2	1.968	2	2.032
3	2.953	3	3.048
4	3.937	4	4.064
5	4.921	5	5.080
6	5.905	6	6.096
7	6.889	7	7.112
8	7.874	8	8.128
9	8.858	9	9.144
10	9.842	10	10.16
50	49.21	50	50.80
100	98.42	10	101.60

Length Conversions cms/inches			
centimetres (cm)	inches (in)	inches (in)	centimetres (cm)
1	0.3937	1	2.54
2	0.7874	2	5.08
3	1.1810	3	7.62
4	1.5750	4	10.16
5	1.9690	5	12.70
6	2.3620	6	15.24
7	2.7559	7	17.78
8	3.1500	8	20.32
9	3.5430	9	22.86
10	3.9370	10	25.40
50	19.690	50	127.0
100	39.370	10	254.0

Length Conversions klms/miles			
Kilometre (km)	Miles	Miles	Kilometre (km)
1	0.6214	1	1.609
2	1.243	2	3.219
3	1.864	3	4.828
4	2.485	4	6.437
5	3.107	5	8.047
6	3.728	6	9.656
7	4.350	7	11.27
8	4.971	8	12.87
9	5.592	9	14.48
10	6.214	10	16.09
50	31.07	50	80.47
100	62.14	10	160.90

Pressure Conversion psi/MPa			
psi	MPa	MPa	psi
1	0.006895	0.1	14.5
50	0.3447	0.2	29.01
100	0.6895	0.3	43.51
200	1.379	0.4	58.02
300	2.068	0.5	72.52
400	2.758	0.6	87.02
500	3.447	1.0	145.0
600	4.137	1.5	217.6
700	4.826	2.0	290.1
800	5.516	2.5	362.6
900	6.205	3.0	435.1
1000	6.895	3.5	507.6
1100	7.584	4.0	580.2
1200	8.274	4.5	652.7
1300	8.963	5.0	725.2
1400	9.653	5.5	797.7

Pressure Conversion psi/MPa			
psi	MPa	MPa	psi
1500	10.34	6.0	870.2
1600	11.03	6.5	942.7
1700	11.72	7.0	1015
1800	12.41	8.0	1160
1900	13.10	9.0	1305
2000	13.79	10.0	1450
2100	14.48	11.0	1595
2200	15.17	12.0	1740
2300	15.86	13.0	1885
2400	16.55	14.0	2031
2500	17.24	15.0	2176
2600	17.93	16.0	2321
2700	18.62	17.0	2466
2800	19.31	18.0	2611
2900	19.99	19.0	2756
3000	20.68	20.0	2901

Useful Conversion Factors

Imperial to Metric (approximate)

“SI” denotes the INTERNATIONAL SYSTEM of Metric Units adopted in Australia

This table may be used in two ways:
 Multiply column “A” by column “B” to obtain column “C”
 Alternatively Divide column “C” by column “B” to obtain column “A”

Remarks	A Multiply	B By	C To obtain
AREA: Symbol m ² The SI unit of AREA is the SQUARE METRE.	Square inches	645.16	mm ²
	Square feet	0.929	m ²
	Square yards	0.836	m ²
	Acre	4047	m ²
	Hectare (ha)	10 000	m ²
DENSITY: Symbol kg/m ³ The SI unit of DENSITY is the kilogram per cubic metre.	lb/in ³	27.68	t/m ³
	lb/ft ³	16.02	kg/m ³
	lb/yd ³	0.5933	kg/m ³
ENERGY: Symbol J The SI unit of ENERGY is the JOULE. 1 J = 1 N.m A joule is the energy expended or the work done when a force of one newton moves the point of application a distance of one metre in the direction of that force.	1.ELECTRICAL ENERGY		
	kilowatt hour (kW.h)	3.6	MJ
	2.HEAT ENERGY		
	British thermal unit (Btu)	1.055	kJ
	Btu/gal	0.2321	kJ/L ++
	Btu/ft ³	37.26	kJ/M ³
	3.MECHANICAL ENERGY		
	foot poundal		
	ft.pdl	.04214	J
	inch pound-force		
in.lbf	0.1130	J	
foot pound-force			
ft.lbf	1.356	J	
foot ton force			
ft.tonf	3.037	kJ	
Metre kilogram force			
m.kgf	9.807	J	
FORCE: Symbol N (NEWTON) The SI unit of FORCE (kg.m/s ²) has been given the special name – NEWTON. The newton is the force which when applied to a body having a mass of one kilogram, causes an acceleration of one metre per second in the direction of application of the force.	Poundal (pdl)		
	Pound-force (lbf)	0.1383	N
	ton-force (tonf)	4.448	N
	*kilogram-force (kgf)	9.964	kN
	*also known as kilopond (kp)	9.807	N
FORCE PER UNIT LENGTH: The SI unit is NEWTON PER METRE: Symbol N/m	pounds-force per inch (lbf/in)	175.1	N/m
	pounds-force per foot (lbf/ft)	14.59	N/m
	ton-force per foot (ton/ft)	32.69	kN/m

TEMPERATURE

The SI unit of TEMPERATURE is the KELVIN - Symbol K. For most practical purposes of temperature measurement and most calculations involving temperatures, degrees Celsius, symbol °C will be used.

DEGREES FAHRENHEIT TO CELSIUS

$$^{\circ}\text{F} - 32) \times 5/9 = ^{\circ}\text{C}$$

DEGREES CELSIUS TO FAHRENHEIT

$$(^{\circ}\text{C} \times 9/5) + 32 = ^{\circ}\text{F}$$

Useful Conversion Factors

Imperial to Metric (approximate)

“SI” denotes the INTERNATIONAL SYSTEM of Metric Units adopted in Australia

This table may be used in two ways:
 Multiply column “A” by column “B” to obtain column “C”
 Alternatively Divide column “C” by column “B” to obtain column “A”

Remarks	A Multiply	B By	C To obtain
LENGTH: Symbol m The SI unit of LENGTH is the METRE.	inches	25.4	millimetres (mm)
	feet	0.3048	metres (m)
	yards	0.9144	metres (m)
	chain	20.12	metres (m)
	mile	1609	metres (m)
	mile	1.609	kilometres (km)
MASS: Symbol kg The SI unit of MASS is the KILOGRAM.	ounce	28.35	grams (g)
	pound	0.4536	kilograms (kg)
	slug	14.59	kg
	ton (2240 lb)	1016.05	kg
	short ton (2000 lb)	907.2	kg
	ton (2240 lb)	1.016	tonne (t)
	pounds per foot (lb/ft)	1.488	kg/m
	pounds per yard (lb/yd)	0.4961	kg/m
POWER: Symbol W The SI unit of POWER is the WATT.	Btu per hour (Btu/hr)	0.2931	W
	horsepower (hp)	0.7457	kW
	ton of refrigeration	3.517	kW
PRESSURE: Symbol Pa The SI unit of PRESSURE or stress is the NEWTON PER SQUARE METRE which has been given the name PASCAL. 1 N/m ² = 1Pa = 0.000145 lbf/in ² A pascal is the pressure or stress which arises when a force of one newton is applied uniformly over an area of one square metre.	lbf/in ²	6.895	kPa
	kip/in ² (1000 psi)	6.895	MPa
	lbf/ft ² 47.88 Pa	47.88	Pa
	kgf/cm ²	98.07	kPa
	bar	100	kPa
	Vertical column (head) of water.		
	(H ₂ O at 20°C)	9.79	kPa
	metres of water	2.984	kPa
	feet of water	0.1333	kPa
	torr (vacuum)	0.1333	kPa
	1mm Hg. (mercury) 1in. Hg.	3.386	kPa
	(mercury) atmosphere (atm) microns	101.325	kPa
		0.133	Pa
TORQUE: Symbol N.m (Moment of force) The SI unit of TORQUE is the NEWTON METRE. The newton metre is the work done when a force of one newton moves the point of application a distance of one metre in the direction of that force. 1 N.m = 1 J	Poundal-foot		
	pdl.ft	.04214	N.m
	pound-force inch		
	lbf.inch	0.1130	N.m
	lbf.inch	1.152	kgf.cm
	pound-force feet		
	lbf.ft	1.356	N.m
	lbf.ft	13.83	kgf.cm
	ton-force feet		
	tonf.ft	3.037	kN.m
kilogram-force			
kgf.m	9.807	N.m	
kgf.cm	0.09807	N.m	
VELOCITY: Symbol m/s The SI unit of VELOCITY is the METRE PER SECOND.	ft. per second (ft/s)	0.3048	m/s
	ft. per minute (ft/min)	0.00508	m/s
	miles per hour	0.4470	m/s
	miles per hour	1.609	km/h

Useful Conversion Factors

Imperial to Metric (approximate)

“SI” denotes the INTERNATIONAL SYSTEM of Metric Units adopted in Australia

This table may be used in two ways:
 Multiply column “A” by column “B” to obtain column “C”
 Alternatively Divide column “C” by column “B” to obtain column “A”

Remarks	A Multiply	B By	C To obtain	
VOLUME: CAPACITY: Symbol m ³ The SI unit of VOLUME is the CUBIC METRE.	DRY:			
	cubic inch (in ³)	16387	mm ³	
	cubic foot (ft ³)	0.02832	m ³	
	cubic yard (yd ³)	0.7646	m ³	
	litre (L) ++	1 000 000	mm ³	
	litre (L) ++	0.001	m ³	
NOTE: ++ Capital “L” is now the legal preferred symbol for litre in Australia.	IMPERIAL LIQUID			
	fluid ounce	28.41	millilitre (ml)	
	pint (20 fl. oz)	568.3	millilitre (ml)	
	quart (2 pints)	1.137	litre (L) ++	
	gallon (Imp.)	4.546	litre (L) ++	
	gallon (US)	3.785	litre (L) ++	
	litre (water 4oC)	1.000	kilogram (kg)	
	Imp. gallons (water 20oC)	4.536	kilogram (kg)	
	VOLUME: RATE OF FLOW Symbol m ³ /s The SI unit of VOLUME RATE OF FLOW is the CUBIC METRE PER SECOND.	Imp. gal. per minute (gal/min)	.0000758	m ³ /s
		Imp. gal. per minute	0.272765	m ³ /hr
Imp. gal. per minute		.0758	litre per second (L/s)	
cubic ft. per minute		.000472	m ³ /s	
cubic ft. per minute		0.472	litre per second (L/s) 1m ³ = 1kl	
SUNDRY ITEMS:	miles per gallon	0.3540	km per litre	
	gallons per mile	2.825	litres per km	

TEMPERATURE

The SI unit of TEMPERATURE is the KELVIN - Symbol K. For most practical purposes of temperature measurement and most calculations involving temperatures, degrees Celsius, symbol °C will be used.

DEGREES FAHRENHEIT TO CELSIUS

$$(^{\circ}\text{F} - 32) \times 5/9 = ^{\circ}\text{C}$$

DEGREES CELSIUS TO FAHRENHEIT

$$(^{\circ}\text{C} \times 9/5) + 32 = ^{\circ}\text{F}$$

Handy Tips

To calculate the mass of flats, squares and rounds.

$$\text{Flats: Width (mm) x Thickness (mm) x 0.00785 = kg/m}$$

$$\text{Squares: Size (mm}^2\text{) x 0.00785 = kg/m}$$

$$\text{Rounds: Diameter (mm}^2\text{) x 0.006165 = kg/m}$$

Some Mass Calculations as indicated on pages 13-15 include a 2.5 per cent rolling tolerance.

To calculate the mass of steel plate sections

Mass = t x 7.850 x (L x W) where:

Mass = mass/metre²

t = thickness of plate

L = length of plate

W = width of plate

To calculate the mass for Floor plate, add 2 kg/m²

kg/m

mm

m

m

To calculate the mass of steel circular hollow sections (CHS) (as used in Australian Standards AS/NZS 1163)

$$\text{Circular sections}$$

$$\text{Mass} = (\text{OD} - \text{wt}) \times \text{wt} \times 0.0246615.$$

where: Mass = mass/metre

OD = outside diameter

wt = section thickness

kg/m

mm

mm

Property of Steel	Symbol	Value
Young's Modulus of Elasticity	E	200 x 10 ³ MPa
Shear Modulus of Elasticity	G	80 x 10 ³ MPa
Density	ρ	7850 kg/m ³
Poisson's Ratio	ν	0.25
Coefficient of Thermal Expansion	α _T	11.7 x 10 ⁻⁶ per °C

To determine the length of conveyor belting
Measure in inches from the outside of the roll to the opposite side of the centre opening S. Count the number of layers or turns of belt N. C is constant = 0.2618 $L = S \times N \times C = \text{Length in feet} / 3.28 = \text{metres}$ eg. 26" x 61 x 0.2618 = 415.22' divide by 3.28 = 126.6m

Relevant Australian Standards

AS 1074:1989	Steel tubes and tubulars for ordinary service
AS 1085.1:2002 Supp 2017	Railway track material - Steel rails - History (Supplement 1 to AS 1085.1-2002)
AS 1085.17:2003 (R2013)	Railway track material Steel sleepers
AS/NZS 1163:2016	Cold-formed structural steel hollow sections
AS/NZS 1365:1996 (R2016)	Tolerances for flat-rolled steel products
AS 1397:2011/Amdt 1-2012	Continuous hot-dip metallic coated steel sheet and strip - Coatings of zinc and zinc alloyed with aluminium and magnesium
AS 1442:2007 (R2017)	Carbon steels and carbon-manganese steels - Hot rolled bars and semi-finished products
AS 1443:2004	Carbon and carbon-manganese steel - Cold-finished bars
AS 1444:2007 (R2017)	Wrought alloy steels - Standard, hardenability (H) series and hardened and tempered to designated mechanical properties
AS 1445:2013	Hot-dipped zinc-coated, aluminium/zinc-coated or aluminium/zinc/magnesium-coated steel sheet — 76 mm pitch corrugated
AS 1447:2007 (R2017)	Hot-rolled spring steels
AS 1448:2007/Amdt 1-2008	Carbon and carbon-manganese steels - Forgings (ruling section 300 mm maximum)
AS 1450:2007 (R2017)	Steel tubes for mechanical purposes
AS/NZS 1594:2002 (R2016)	Hot-rolled steel flat products
AS/NZS 1595:1998 (R2016)/Amdt 1:2014	Cold-rolled, unalloyed, steel sheet and strip
AS 2551:1982 (R2016)	Steel sheet and strip - Cold-rolled, electrolytic zinc-coated
AS 3597:2008	Structural and pressure vessel steel - Quenched and tempered plate
AS/NZS 3678:2016	Structural steel – Hot-rolled plates, floorplates and slabs
AS/NZS 3679.2-2010	Structural steel Part 1: Hot-rolled bars and sections
AS/NZS 3679.2:2016	Structural steel Part 2: Welded I sections
AS/NZS 4496:1997 (R2016)	Recommended practice for the colour coding of steel products
AS/NZS 4600:2018	Cold-formed steel structures
AS/NZS 4671:2001	Steel reinforcing materials
SA TS 102:2016	Structural steel – (Technical Specification) Limits on elements added
SA TS 103:2016	Structural steel – (Technical Specification) Limits on boron in parent materials.

Important Details



Your Local Outlet

My Local InfraBuild Steel Centre outlet details

Phone:	Fax:	Email:
--------	------	--------

My Local InfraBuild Steel Centre Account Representatives

Sales:

Phone:	Fax:	Email:
--------	------	--------

Phone:	Fax:	Email:
--------	------	--------

Credit:

Phone:	Fax:	Email:
--------	------	--------

Phone:	Fax:	Email:
--------	------	--------

My Local InfraBuild Steel Centre Account Number

A/C N:

My Industry Memberships

A/C N:

--

Note: InfraBuild Steel Centre reserve the right to change specifications without notice. Not all products are available at all InfraBuild Steel Centre branches. InfraBuild Steel Centre also has access to a wide network of products not necessarily listed in this book. Please check with your local InfraBuild Steel Centre branch for product availability.

Find your local
InfraBuild Steel Centre:
www.infrabuild.com

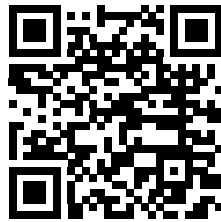

Please note that any specifications or technical data referred to in this publication are subject to change and/or variation or improvement without notice and no warranty as to their suitability for any use is made. Photographs shown are representative only of typical applications. This brochure is not an offer to trade and shall not form any part of the trading terms in any transaction. Copyright 2022 InfraBuild Trading Pty Limited (ABN 50 007 519 646).

